

2004
—
2005

Product Catalog



WATER COOLED CONDENSERS
CHILLER BARRELS
REFRIGERANT SUBCOOLERS
LIQUID RECEIVERS
SUCTION ACCUMULATORS
SUCTION LINE HEAT EXCHANGERS
VALVES, BRACKETS AND ACCESSORIES
INDUSTRIAL REFRIGERATION PRODUCTS



Standard
Refrigeration Company

Pressure Vessel Fabrication Information		4
Water-Cooled Condensers		5
HSE	<i>Shell & Tube</i>	6
SST	<i>Shell & Tube</i>	8
HP	<i>High Pressure/High Pumpdown</i>	10
CA	<i>Stainless Steel Shell & Tube</i>	11
VSE	<i>Shell & Coil</i>	12
ELT	<i>Tube in Tube</i>	14
KHX	<i>Tube in Tube</i>	15
MSE	<i>Marine Shell & Tube</i>	16
SCS/SCH	<i>Coaxial</i>	18
Replacement Condenser Gaskets & Endplates Cross Reference Chart		20
Chiller Barrels		26
Chiller Barrel Sizing		26
Chiller Barrel Ratings & Design Features		27
TX	<i>Ultra Compact Serviceable Chiller Barrels</i>	28
ER	<i>OEM Single and Three-Pass Replacement Chiller Barrels</i>	32
Ice Rink Chiller Barrels		33
Replacement Chiller Barrel Gaskets Cross Reference Chart		34
Refrigerant Subcoolers		35
SCT	<i>Vertical Subcoolers</i>	35
Chiller Builder Kits		36
CB Kits	<i>Low-side chiller packages</i>	36
Liquid Receivers		38
Receiver Ratings & Design Features		38
HR	<i>Horizontal Design</i>	39
RBV	<i>Horizontal Design with Valves & Brackets</i>	40
UR	<i>Vertical Design</i>	41
UV	<i>Vertical Design with Valves</i>	42
L	<i>Compact Design</i>	43

C O N T E N T S

Suction Accumulators 44

A	<i>Accumulators</i>	44
---	---------------------	----

Suction Line Heat Exchangers 45

SLC	<i>Copper Design</i>	45
SLS	<i>Carbon Steel Design</i>	45

Valves, Brackets and Accessories 46

Rotalock Valves		46
Compressor Valves & Indicator Components		47
Indicators & Alarms		48
Adapters		49
Fusible Plugs, Unions and Valves		50
Sightglasses		50
Brackets		51

Industrial Refrigeration Products 52

OCS	<i>Coalescing Oil Separators</i>	53
OCSF	<i>Serviceable Coalescing Oil Separators</i>	53
TSC	<i>Thermosyphon Oil Coolers</i>	54
OTW	<i>Water Cooled Oil Coolers</i>	55
AMC	<i>Ammonia Condensers</i>	56
AOP	<i>Oil Pots</i>	57
AFV	<i>Ammonia Flooded Evaporators</i>	57

Custom Product Specification Forms 58-59

Warranty Back Cover

Pressure Vessel Fabrication & Codes

Size of Vessel

Construction and Certification
generally acceptable, furnished
unless otherwise specified

Under six inches ID

UL Listing

Six inches or greater ID, but less than
1.5 cubic feet net internal volume

ASME Code Construction with
UM Certification and UL Recognition

Six inches or greater ID, with over 1.5
cubic feet net internal volume

ASME Code Construction with U
Certification and National Board
Registration

Notes

UL Listing may be obtained for a vessel, typical samples of which can withstand five times the marked working pressure without failure for the gas side and three times the marked working pressure without failure for the fluid side. Initial tests are made at Underwriters Laboratory and reexamination tests are made under UL supervision, at the manufacturer's plant.

ASME Code Construction is the same whether UM or U certified. Essentially, the vessel must have a calculated design strength capable of withstanding the maximum allowable working pressure (MAWP) and tested pneumatically to 1.1 time the MAWP or hydrostatically to 1.3 times the MAWP. Certain details of construction must be observed, and chemical and physical test certification for all material must be on file. Welding procedures, equipment, and personnel must be qualified by performance tests. UM Certification means that the manufacturer's personnel have performed the necessary inspection and tests. The letters UM appear in the ASME cloverleaf stamp on the tag. Only when requested, a certificate (Form U-3) is furnished, signed by the manufacturer.

UL Recognition of UM vessels. Their testing, and reexamination procedure is identical to that for listing. This recognition requirement comes about because UL takes the position that someone other than the manufacturer should check the construction. The recognition list is not published—as is the listing—the records are kept by UL and generally used only when granting listing to an assembly that includes the vessel.

National Board Registration means that in addition to the ASME construction, an independent, licensed inspector has monitored the procedures, fabrication and testing of the vessel. The letter U appears in the ASME cloverleaf stamp on the tag. We recommend referring to Nat. Bd., rather than U-stamp, to avoid confusion between U and UM.

Underwriters Laboratory will automatically accept a National Board registered vessel when listing an assembly, because it has been inspected by an independent agent, to specifications more strict than their own.

A National Board certified vessel is accepted by all state and municipal codes in the United States. Most other countries will accept them also.

Certain government or military requirements essentially parallel the ASME code, but may specify approval and/or certification by inspectors from a government agency in addition to, or in place of ASME code, or UL requirements.

International Code Stamps

CRN Canadian registration is available on cataloged models. CRN or special code requests should be made at time of order.

Other international codes possibly available upon request include New Zealand, Australia, Japan, China and Europe (CE).

Condensers



HSE



SST



HP



CA



VSE

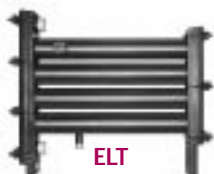

ELT

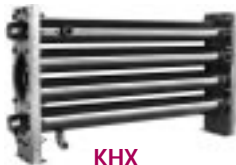

KHX



MSE



SCH / SCS

design features & ratings

Nominal Horsepower Rating Basis

15,000 Btu per hour @ 85°F. inlet water, 0.00025 additive fouling factor and 105°F. condensing temperature, with a three gallon per minute (gpm) water flow and refrigerant 22.

Sizing by Nominal Horsepower

A condenser is properly sized when its capacity to transfer heat from the system is equal to the cooling load, plus the extra heat generated by the work of compressing the gas. This total is called the Total Heat of Rejection. For air-conditioning or a high back pressure system, it's safe and convenient to size by nominal horsepower. However, matching nominal HP can result in over-sizing for low and very low temperature applications. When your application varies from nominal-air conditioning or normal operating conditions utilize Standard Refrigeration's CSCAN selection software or condenser performance tables, which can be obtained at www.stanref.com or from customer service.

Pumpdown Capacity

Pumpdown figures have been compensated to provide capacity for R-22 based on 80% of condenser volume filled with liquid at 90°F.

Pumpdown requirements relate to the amount of refrigerant storage available in a condenser during operation or servicing. A pumpdown capacity of three pounds of refrigerant per ton will be sufficient for high back-pressure air conditioning, five pounds per ton for medium back-pressure air conditioning and up to seven pounds per ton for commercial refrigeration/low back-pressure systems.

Operating Charge

Approximately 10% of the pumpdown capacity is required for shell & tube models and 5% for shell & coil models for proper operation.

Nominal Water Pressure Drop

Nominal pressure drops (psi) given are at nominal flow rates. To determine nominal flow rates multiply nominal horsepower (hp) by 3.0. Water pressure drops provided do not include any external fittings or valves.

Pressure drop is defined as the loss of pressure due to friction and is the pressure difference between entering and leaving water sides.

Water Flow

Velocities of eight feet per second or higher risk premature impingement corrosion and tube failure. Operation below minimum flow rates may result in excessive fouling and poor heat transfer. All values in this catalog section are limited to flows below eight feet per second.

Custom Designs

Standard Refrigeration is always happy to design and build customized condensers if an application calls for special materials, additional valves, water or refrigerant fittings, mounting brackets or other accessories. Contact customer service for a quotation.

HSE

Horizontal Super Efficient Water Cooled Condensers

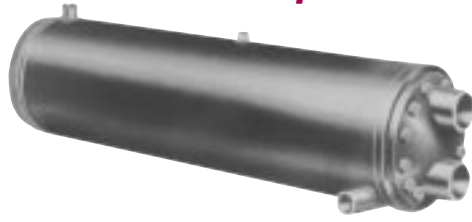

design features & ratings

MODELS	Nominal hp		Dimensions (inches)							Connections (inches)			
	clean	fouled	D	L	A	B	E	F	R	P (ids)	Q (ids)	S (fpt)	T (fpt)
HSE-2	3.3	2.1	5	27 1/8	2	22	1 5/8	1 3/4	1 3/8	5/8	1/2	3/8	3/8
HSE-3	4.3	3.7	6	27 1/8	2	22	1 7/8	1 3/4	1 3/8	7/8	5/8	3/8	3/8
HSE-5	8.3	5.1	6 5/8	27 7/8	2 1/2	21 1/2	2	2 1/8	1 3/4	1 1/8	5/8	1/2	1
HSE-7	8.8	7.4	6 5/8	39 7/8	2 1/2	33 1/2	2	2 1/8	1 3/4	1 3/8	7/8	1/2	1 1/4
HSE-10	11.4	9.8	6 5/8	39 7/8	2 1/2	33 1/2	2	2 1/8	1 3/4	1 3/8	7/8	1/2	1 1/4
HSE-15	17.6	14.8	8 5/8	39 1/8	3	33	2 1/8	1 3/4	1 3/8	1 5/8	1 1/8	1/2	2
HSE-20A	33.0	20.2	8 5/8	51 1/8	3	45	2 1/8	1 3/4	1 3/8	1 5/8	1 1/8	1/2	2
HSE-25A	34.5	23.1	8 5/8	51 1/8	3	45	2 1/8	1 3/4	1 3/8	2 1/8	1 3/8	1/2	2
HSE-30A	41.7	29.0	10 3/4	53 3/8	3	45	2 1/8	2 1/8	1 3/4	2 1/8	1 3/8	1/2	2 1/2
HSE-40A	48.1	40.2	10 3/4	64 3/8	3	57	2 1/8	2 1/8	1 3/4	2 1/8	1 3/8	1/2	3
HSE-50A	63.2	52.4	10 3/4	64 3/8	3	57	2 1/8	2 1/8	1 3/4	2 5/8	1 5/8	1/2	3
HSE-60	82.5	60.3	12 3/4	66 3/4	3 1/2	56 1/2	2 3/4	4 1/4	2 3/8	2 5/8	1 5/8	1/2	4
HSE-70	95.1	70.3	12 3/4	66 3/4	3 1/2	56 1/2	2 3/4	4 1/4	2 3/8	3 1/8	2 1/8	1/2	4
HSE-80	110.1	82.2	12 3/4	66 3/4	3 1/2	56 1/2	2 3/4	4 1/4	2 3/8	3 1/8	2 1/8	1/2	4
HSE-100	151.7	99.0	12 3/4	109 5/8	3 1/2	92 1/2	5 1/16	—	6 5/8	3 1/8	2 1/8	3/4	5
HSE-125	162.8	124.2	12 3/4	109 5/8	3 1/2	92 1/2	5 1/16	—	6 5/8	3 5/8	2 1/8	3/4	5
HSE-150	231.7	162.6	14	113 3/4	5 3/8	90 5/8	10 7/8	—	8 7/8	3 5/8	2 5/8	3/4	6 flange
HSE-200	280.7	203.7	16	114	5 3/8	90 5/8	11 7/8	—	9	4 1/8	3 1/8	3/4	8 flange
HSE-250	393.1	265.1	18	116	5 3/8	90 5/8	12 7/8	—	10	4 1/8	3 1/8	3/4	8 flange
HSE-300	463.4	325.3	20	116	5 3/4	90 1/4	13 7/8	—	10	4 1/8	3 5/8	3/4	10 flange
HSE-350	529.6	344.0	20	116	5 3/4	90 1/4	13 7/8	—	10	5 1/8	3 5/8	3/4	10 flange
HSE-400	594.7	418.2	24	123	5 7/8	90 1/8	15 7/8	—	13 1/2	5 1/8	4 1/8	3/4	12 flange
HSE-500	805.4	510.7	24	123	5 7/8	90 1/8	15 7/8	—	13 1/2	6 1/8	4 1/8	3/4	12 flange

Clean ratings: As tested per ARI Standard 450-99

Fouled ratings: Include a additive fouling coefficient of 0.00025 as calculated per ARI Standard 450-99

† Tubing has high performance extended surface

• Constructed with three water fittings. Parallel outer fittings for nominal flow. HSE-3 has 1/2" center fitting

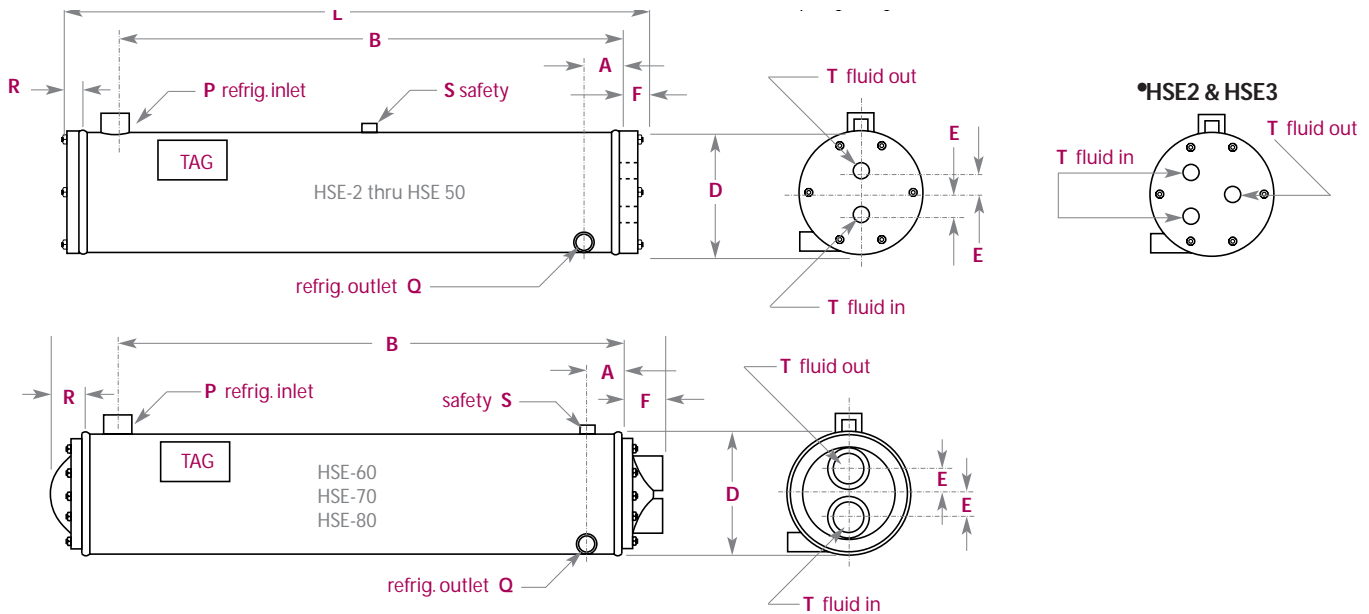

- Horizontal, cleanable shell and tube design
- New high tech enhanced copper tube geometry
- Smaller foot-print equals less space requirement
- Removable, epoxy coated, water plates to facilitate cleaning
- Epoxy coated tube sheets to prevent pitting caused by galvanic action
- Custom models available thru 800 horsepower
- 23 HSE models, 2 thru 500 horsepower

MODELS	Pumpdown Capacity (lbs)	Waterflow (gpm)		Water Pressure Drop (psi)	Shipping Weight (lbs)	Working Pressure (psi)	
		Min.	Max.			Shell Side	Tube Side
HSE-2	12	1.3	13	2.0	36	400	150
HSE-3	16	1.3	13	6.7	48	400	150
HSE-5	20	2.7	27	3.1	66	400	150
HSE-7	30	2.4	23	6.8	96	400	150
HSE-10	27	3.4	34	6.6	89	400	150
HSE-15	50	4.7	47	8.3	143	400	150
HSE-20A	63	10.7	107	3.2	184	400	150
HSE-25A	61	12.1	121	4.6	193	400	150
HSE-30A	102	15	154	4.0	291	400	150
HSE-40A	127	15	154	6.5	348	400	150
HSE-50A	118	19	188	7.0	355	400	150
HSE-60	176	22	221	4.6	461	400	150
HSE-70	167	25	255	4.4	480	400	150
HSE-80	157	29	295	4.6	518	400	150
HSE-100	268	51	509	1.8	751	400	150
HSE-125	239	64	643	1.6	812	400	150
HSE-150	271	86	858	1.3	1300	400	150
HSE-200	356	114	1139	1.3	1600	400	150
HSE-250	449	143	1434	1.35	2000	400	150
HSE-300	601	170	1702	1.25	2600	350	150
HSE-350	550	194	1944	1.36	2800	350	150
HSE-400	914	228	2279	1.34	3300	350	150
HSE-500	791	286	2855	1.34	3700	350	150

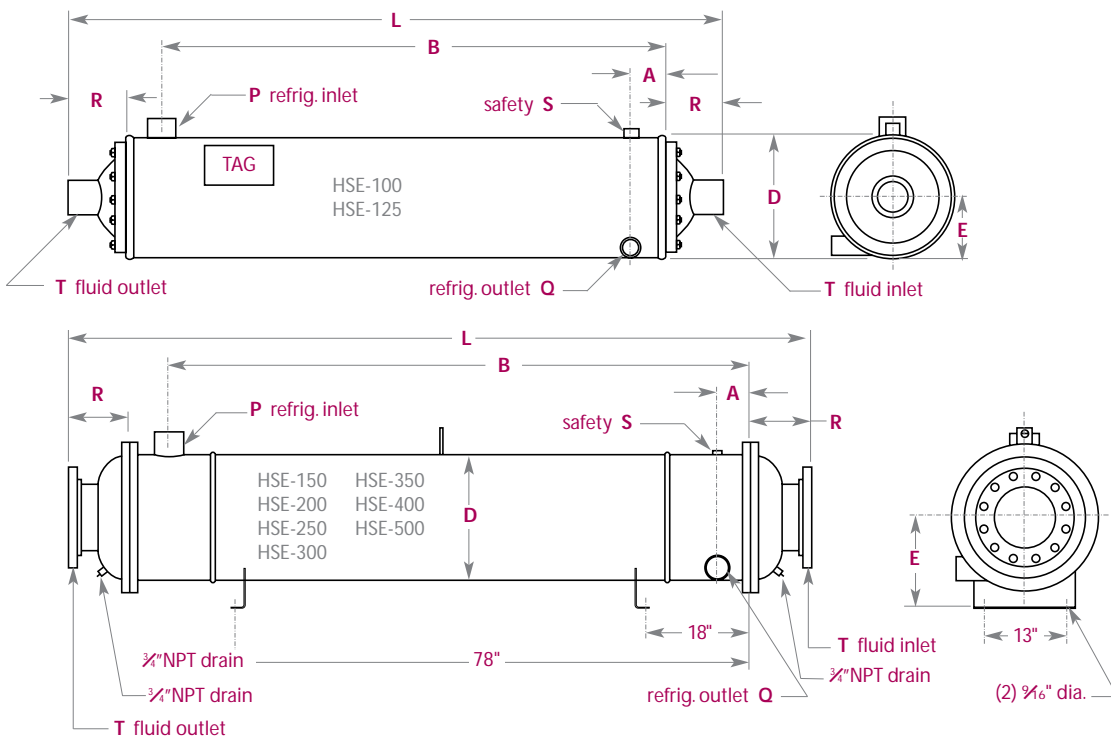



design features & ratings

MODELS	Nominal hp		Dimensions (inches)							Connections (inches)			
	clean	fouled	D	L	A	B	E	F	R	P (ids)	Q (ids)	S (fpt)	T (fpt)
SST-75A	1.2	0.8	5	20 7/8	2	16	1 5/8	1 1/2	5/8	1/2	1/2	3/8	3/8
SST-100A	1.7	1.6	6	21 3/8	2 1/8	15 7/8	1 7/8	1 5/8	5/8	5/8	1/2	3/8	1/2
SST-200A	3.5	2.3	6 5/8	21 3/8	2 1/16	16	1	2	5/8	7/8	5/8	3/8	3/4
SST-300A	5.6	3.9	6 5/8	27 3/8	2 1/16	22	1	2	5/8	7/8	5/8	3/8	3/4
SST-500A	7.2	5.2	8 5/8	28	2 5/8	21 1/2	1 1/2	2 1/4	1	1 1/8	5/8	1/2	1 1/4
SST-750A	10.8	7.8	8 5/8	28 1/2	2 1/2	21 1/2	1 1/2	2 1/4	1	1 3/8	7/8	1/2	1 1/4
SST-755A	9.7	8.5	8 5/8	40 1/2	2 9/16	33 1/2	1 1/2	2 1/4	1	1 3/8	7/8	1/2	1 1/4
SST-1000A	16.0	10.3	8 5/8	46 1/2	2 9/16	39 1/2	2 1/8	2 1/4	1	1 3/8	7/8	1/2	1 1/4
SST-1500A	24.5	15.5	8 5/8	52	2 9/16	45 1/2	2 1/8	2 1/4	1	1 3/8	1 1/8	1/2	1 1/2
SST-1555A	24.5	15.5	10 3/4	53 1/4	3	44 3/4	2 1/2	3	1 3/8	1 5/8	1 1/8	1/2	1 1/2
SST-2005A	30.0	22.1	10 3/4	65 1/4	3	56 1/2	2 1/2	3	1 3/8	2 1/8	1 1/8	1/2	2
SST-2026A	30.0	22.1	12 3/4	65 1/4	3 1/4	56 1/2	2 1/2	3	1 3/8	2 1/8	1 1/8	1/2	2
SST-2505A	37.5	27.7	10 3/4	65 1/2	3	56 1/2	2 1/8	3 1/4	1 3/8	2 1/8	1 3/8	1/2	2 1/2
SST-2527A	37.5	27.7	12 3/4	65 1/2	3 1/4	56 1/2	2 1/8	3 1/4	1 3/8	2 1/8	1 3/8	1/2	2 1/2
SST-3005A	45.0	33.2	10 3/4	65 1/4	3	56 1/2	2 1/8	3 1/4	1 3/8	2 5/8	1 3/8	1/2	2 1/2
SST-3028A	45.0	33.2	12 3/4	65 1/2	3 1/4	56 1/2	2 1/8	3 1/4	1 3/8	2 5/8	1 3/8	1/2	2 1/2
SST-3505A	50.0	36.9	12 3/4	65 1/2	3 1/4	56 1/2	2 1/8	3 1/4	1 3/8	2 5/8	1 3/8	1/2	2 1/2
SST-4005A	55.0	40.6	14	66 7/8	3 1/4	56 1/2	2 3/4	4 1/4	2 3/8	2 5/8	1 3/8	1/2	3
SST-4505A	65.0	48.0	14	66 7/8	3 1/4	56 1/2	2 3/4	4 1/4	2 3/8	2 5/8	1 5/8	1/2	3
SST-5005A	70.0	51.7	14	66 7/8	3 1/4	56 1/2	2 3/4	4 1/4	2 3/8	2 5/8	1 5/8	1/2	4
SST-5505A	75.0	55.4	14	66 7/8	3 1/4	56	2 3/4	4 1/4	2 3/8	3 1/8	1 5/8	1/2	4
SST-6005A	82.5	60.9	14	66 7/8	3 1/4	56 3/4	2 3/4	4 1/4	2 3/8	3 1/8	2 1/8	1/2	4
SST-7005A	97.6	72.0	14	66 3/4	3 1/4	56	2 3/4	4 1/4	2 3/8	3 1/8	2 1/8	1/2	4
SST-8005A	110.1	81.2	14	66 3/4	3 1/4	56	2 3/4	4 1/4	2 3/8	3 1/8	2 1/8	1/2	4
SST-100-1408A	159.5	100.9	14	107 3/4	3 1/2	92	5 9/16	5 3/4	-	3 1/8	2 5/8	3/4	5
SST-120-1408A	196.4	124.2	14	107 3/4	3 1/2	92	5 9/16	5 3/4	-	3 5/8	2 5/8	3/4	5
SST-150-1410A	210.1	155.0	14	131 3/4	3 1/2	115 1/2	5 9/16	5 3/4	-	3 5/8	2 5/8	3/4	5
SST-200-1412A	268.6	222.1	14	159	4	139	5 9/16	7 1/2	-	4 1/8	3 1/8	3/4	6 flange

Clean ratings: As tested per ARI Standard 450-99

† Tubing has high performance extended surface

Fouled ratings: Include a additive fouling coefficient of 0.00025 as calculated per ARI Standard 450-99

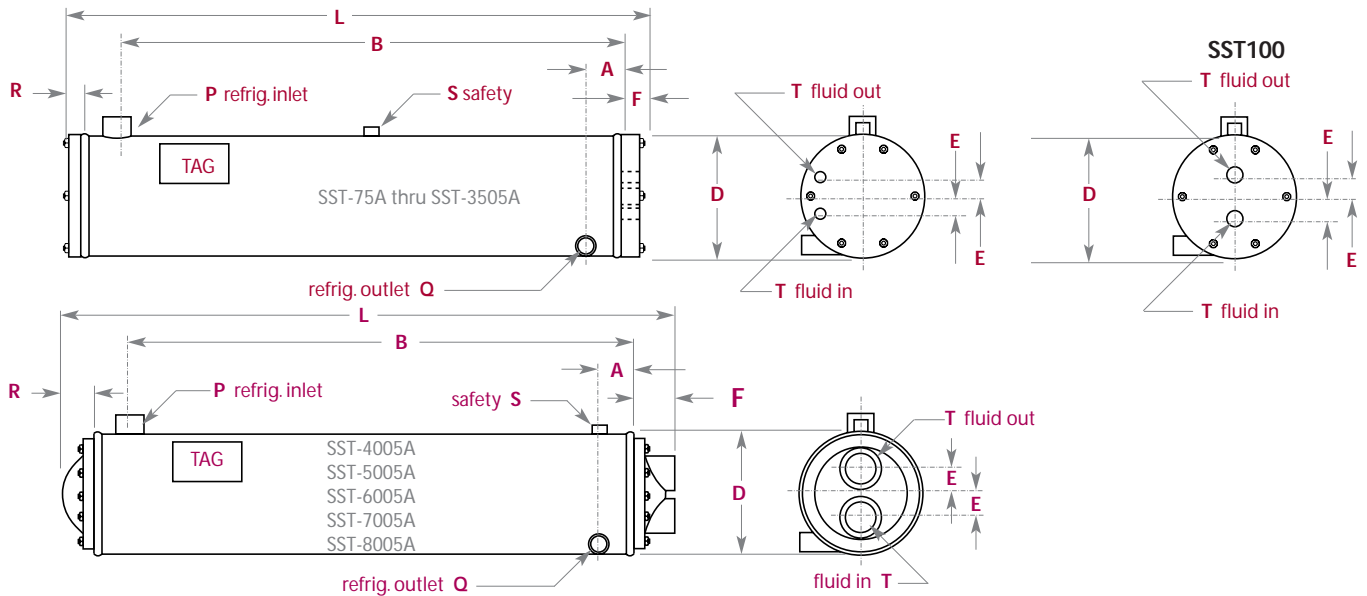

- Industry's most widely used and trusted model
- Heavy duty, horizontal, shell and tube design
- Nominal ratings and sizes to handle the most demanding requirements
- Removable, epoxy coated, water plates to facilitate cleaning
- All copper, heavy wall, straight tube water channels
- Epoxy coated tube sheets to prevent pitting caused by galvanic action
- Generous pumpdown capacities
- Custom models available thru 800 horsepower
- 28 SST models, 3/4 thru 200 horsepower

MODELS	Pumpdown Capacity (lbs)	Waterflow (gpm)		Water Pressure Drop (psi)	Shipping Weight (lbs)	Working Pressure (psi)	
		Min.	Max.			Shell Side	Tube Side
SST-75A	9	0.7	2.3	3.4	28	450	150
SST-100A	17	0.7	4.7	2.7	39	450	150
SST-200A	15	2.0	18.0	1.7	52	450	150
SST-300A	21	2.0	16.0	1.7	71	450	150
SST-500A	35	2.7	26.8	3.5	90	450	150
SST-750A	32	4.0	30.0	2.4	109	450	150
SST-755A	53	3.4	20.0	3.3	144	450	150
SST-1000A	59	6.7	67.0	0.9	159	450	150
SST-1500A	65	8.0	70.0	1.5	180	450	150
SST-1555A	111	8.0	80.4	2.0	272	450	150
SST-2005A	138	8.0	80.4	3.5	313	450	150
SST-2026A	208	8.0	80.4	2.8	428	450	150
SST-2505A	135	10.1	100.5	4.0	345	450	150
SST-2527A	205	10.1	100.5	3.2	413	450	150
SST-3005A	128	12.1	100.1	4.0	350	450	150
SST-3028A	198	12.1	100.1	3.1	448	450	150
SST-3505A	199	13.4	111.2	5.5	400	450	150
SST-4005A	244	14.8	122.3	4.7	489	450	150
SST-4505A	237	17.4	144.6	4.3	519	450	150
SST-5005A	233	18.8	187.7	4.7	527	450	150
SST-5505A	230	20.1	201.1	4.8	521	450	150
SST-6005A	224	22.1	221.2	4.6	542	450	150
SST-7005A	214	26.1	261.4	4.7	548	450	150
SST-8005A	205	29.5	294.9	4.8	596	450	150
SST-100-1408A	342	52.3	522.8	4.7	1136	450	150
SST-120-1408A	316	64.3	643.4	4.7	1176	450	150
SST-150-1410A	416	56.3	563.0	6.7	1298	450	150
SST-200-1412A	474	64.3	643.4	4.8	1505	450	150

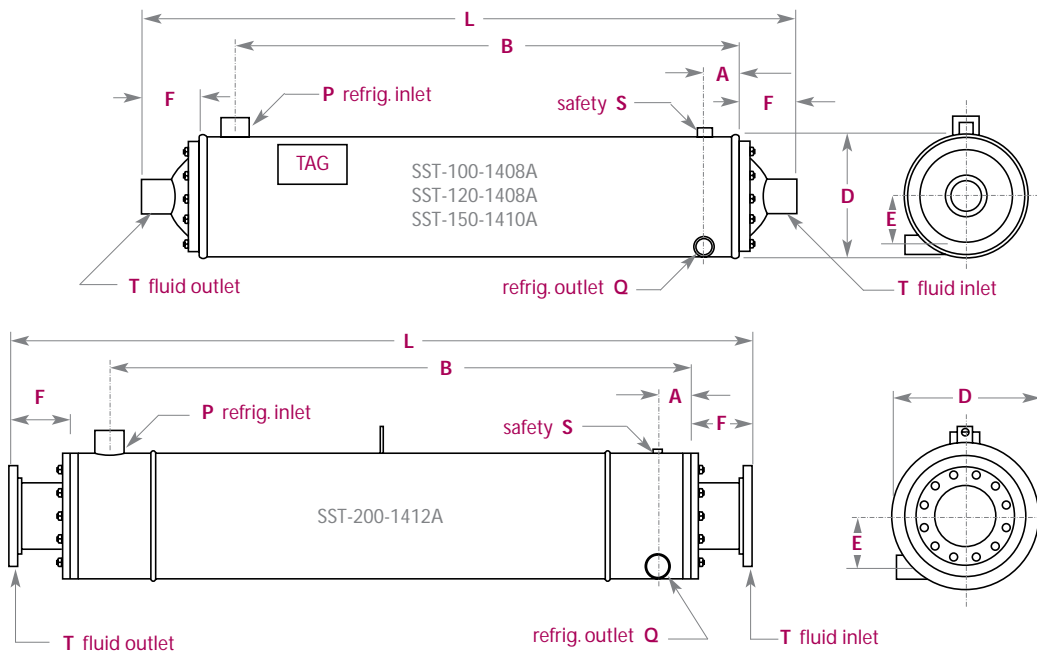

HP

High Pressure/High Pumpdown Condensers



design features & ratings

- Ideal for high-rise building applications
- High Performance, horizontal, shell and tube design
- High Pressure, specially designed removable water plates and gaskets provide for a 300 psi waterside working pressure
- High Pumpdown, for containment of greater refrigerant charges
- New high tech enhanced heat transfer tube surface
- Epoxy coated tube sheets and water plates to prevent pitting caused by galvanic action
- 8 HP models, 10 thru 80 horsepower

MODELS	Nominal hp		Dimensions (inches)							Connections (inches)			
	clean	fouled	D	L	A	B	E	F	R	P (ids)	Q (ids)	S (fpt)	T (fpt)
HP-10	13	11	8 5/8	40 5/8	3 1/4	32 5/8	1 3/8	2 1/2	1 3/8	1 3/8	7/8	1/2	1 1/2
HP-15	16 1/2	14 1/2	8 5/8	52 5/8	3 1/4	44 5/8	1 5/8	2 1/2	1 3/8	1 3/8	7/8	1/2	1 1/2
HP-20	23	20	8 5/8	64 5/8	3 1/4	56 5/8	1 5/8	2 1/2	1 3/8	1 3/8	7/8	1/2	1 1/2
HP-30A	39	33	10 3/4	77	3 1/2	68 5/8	2 3/8	2 1/2	2 3/8	2 5/8	1 5/8	1/2	2
HP-40A	51	44	10 3/4	77	3 1/2	68 5/8	2 3/8	2 1/2	2 3/8	2 5/8	1 5/8	1/2	2
HP-50A	64	55	12 3/4	77 5/8	3 1/2	68 5/8	2 5/8	3 1/8	2 3/8	2 5/8	1 5/8	1/2	3
HP-60A	74	63	12 3/4	77 5/8	3 1/2	68 5/8	2 5/8	3 1/8	2 3/8	2 5/8	1 5/8	1/2	3
HP-80A	100	85	14	77 3/8	3 1/2	68 5/8	2 7/8	2 3/4	2 1/2	3 1/8	2 1/8	1/2	4

Clean ratings: As tested per ARI Standard 450-99

Fouled ratings: Include a additive fouling coefficient of 0.00025 as calculated per ARI Standard 450-99

• Centerline on fittings is located 1 3/8" to the left of centerline on vessel

† Tubing has high performance extended surface

MODELS	Pumpdown Capacity (lbs)	Waterflow (gpm)		Water Pressure Drop (psi)	Shipping Weight (lbs)	Working Pressure (psi)	
		Min.	Max.			Shell Side	Tube Side
HP-10	51	4	40	6.3	125	350	300
HP-15	68	8	80	2.6	145	350	300
HP-20	86	8	80	4.0	205	350	300
HP-30A	160	12	121	4.4	375	350	300
HP-40A	148	16	161	4.4	435	350	300
HP-50A	217	20	201	4.4	555	350	300
HP-60A	213	21	214	5.5	575	350	300
HP-80A	243	29	295	5.2	755	350	300

400 psi shell side on request

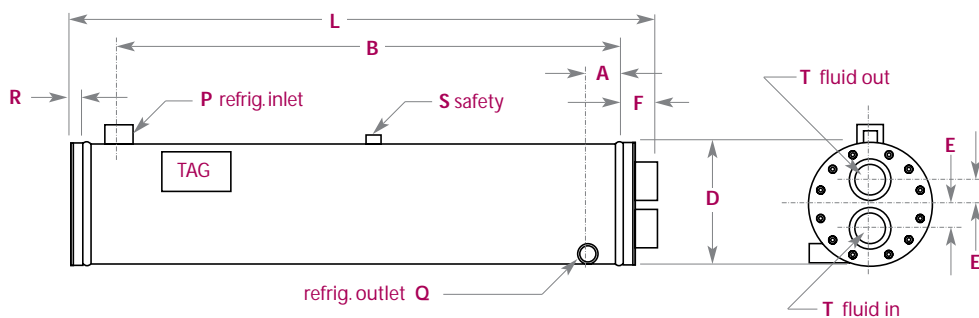

CA

Stainless Steel/Corrosive Fluid Condensers



design features & ratings

- 316 stainless steel tubes
- 304 stainless tubesheets, water plates and waterside fittings for use with corrosive fluids. Especially suitable for pulp and paper mill applications
- Heavy duty, horizontal, shell and tube design
- Rolled tube to tube sheet joints
- Removable water plates to facilitate cleaning
- 6 CA models, 5 thru 30 horsepower

MODELS	Nominal hp		Dimensions (inches)							Connections (inches)			
	clean	fouled	D	L	A	B	E	F	R	P (ids)	Q (ids)	S (fpt)	T (fpt)
CA-050	5 1/2	5	6 5/8	39 1/4	4	32	1 1/8	2 3/8	7/8	1 1/8	7/8	1/2	3/4
CA-075	7 1/2	7	8 5/8	39 5/8	4	32	1 1/2	2 5/8	1	1 3/8	7/8	1/2	1 1/4
CA-100	10	9	8 5/8	39 5/8	4	32	1 1/2	2 5/8	1	1 3/8	7/8	1/2	1 1/4
CA-150	15	14	10 3/4	40 1/8	4	32	2 1/2	3 1/8	7/8	1 5/8	1 1/8	1/2	1 1/2
CA-200	20	18	8 5/8	76 1/8	4	68	2 1/8	3 1/8	1	2 1/8	1 1/8	1/2	1 1/2
CA-300	29	27	10 3/4	76 3/4	4	68	2 1/2	3 3/4	7/8	2 5/8	1 3/8	1/2	2 1/2

Clean ratings: As tested per ARI Standard 450-87

Fouled ratings: Include a additive fouling coefficient of 0.00025 as calculated per ARI Standard 450-87 (.0005 total)

† Tubing has high performance extended surface

MODELS	Pumpdown Capacity (lbs)	Waterflow (gpm)		Water Pressure Drop (psi)	Shipping Weight (lbs)	Working Pressure (psi)	
		Min.	Max.			Shell Side	Tube Side
CA-050	23	2.2	32.8	7.9	115	350	150
CA-075	44	2.9	43.7	9.2	175	350	150
CA-100	40	3.6	54.7	10.0	190	350	150
CA-150	63	5.5	82.0	10.0	265	350	150
CA-200	83	7.3	109.3	6.9	305	350	150
CA-300	131	10.9	164.0	6.9	450	350	150

400 psi shell side on request

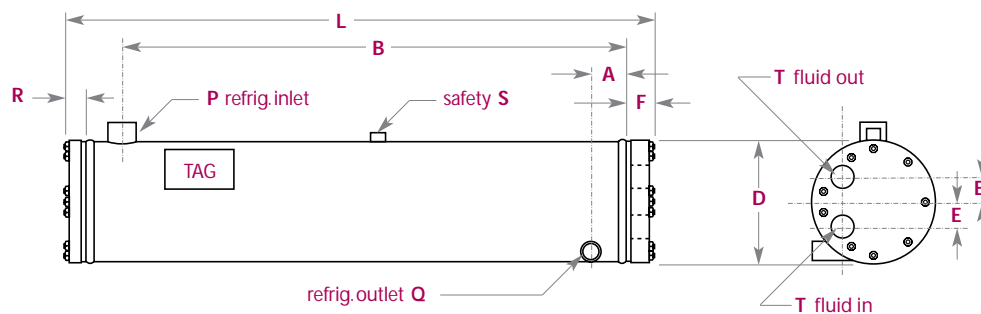

VSE

Vertical Shell & Coil Condensers



design features & ratings

MODELS	Nominal hp		Dimensions (inches)					Connections (inches)				
	clean	fouled	D	H	A	B	C	P (ids)	Q (ids)	S (fpt)	W (fpt)	T (fpt)
VSE-1/2	—	1/2	6	5	1 1/4	3 1/4	1 1/2	1/2	1/2	3/8	—	1/2
VSE-1	—	1	6	5 1/2	1 1/2	3 5/8	1 1/2	5/8	1/2	3/8	—	1/2
VSE-1 1/2	—	1 1/2	8 5/8	6 3/8	2	4 3/8	2	5/8	1/2	3/8	—	3/4
VSE-2	—	2	9 3/4	7 1/4	2 1/8	4 3/4	2	5/8	5/8	1/2	—	3/4
VSE-3	3 1/2	3	6 5/8	13	1 5/8	1 5/8	11 1/8	7/8	5/8	3/8	3/4	—
VSE-5	6	5	8 5/8	13 1/2	1 3/4	4 5/8	11 1/2	1 1/8	5/8	1/2	1	—
VSE-7	9	8	10 3/4	16 1/4	2 5/8	6 1/2	13 3/8	1 3/8	7/8	1/2	1 1/4	—
VSE-10	13	11	16	18 3/4	4 1/2	9	13 3/4	1 3/8	7/8	1/2	1 1/4	—
VSE-10T	12	10	8 5/8	19 1/2	1 3/4	4 5/8	17 1/2	1 3/8	7/8	1/2	1	1 1/2
VSE-15T	19	16	10 3/4	22 1/4	2 5/8	6 1/2	19 3/8	1 5/8	1 1/8	1/2	1 1/4	1 1/2
VSE-20T	26	22	16	23 1/4	4 1/2	9	18 1/4	2 1/8	1 3/8	1/2	1 1/2	2

Clean ratings: As tested per ARI Standard 450-99

Fouled ratings: Include a additive fouling coefficient of 0.00025 as calculated per ARI Standard 450-99

† Tubing has high performance extended surface

VSE-1/2 through VSE-2

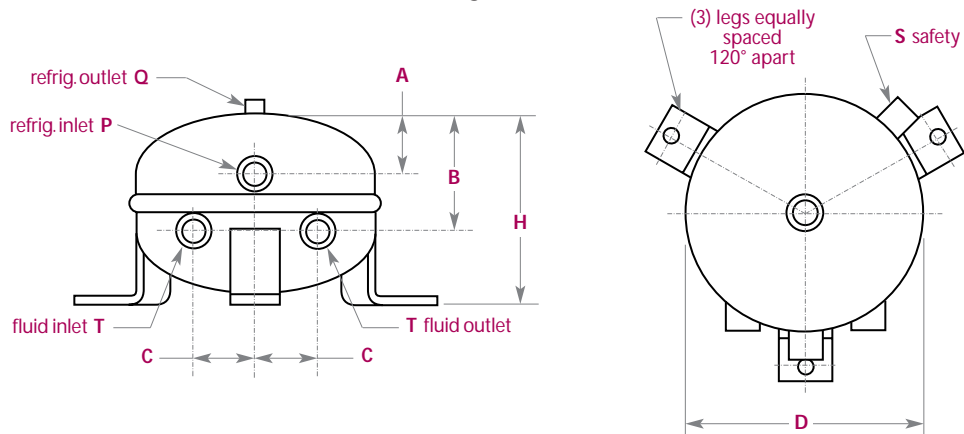

- Sealed construction, vertical, shell and coil design
- Greatest refrigerant pumpdown capacity in a upright compact package
- Special "T" models have auxiliary connection for tower applications or to reduce pressure drops
- Size and efficiency make it ideal for use in small package units; ice makers, vending machines, self contained refrigeration cases
- 11 VSE models, ½ thru 20 horsepower

MODELS	Pumpdown Capacity (lbs)	Waterflow (gpm)		Water Pressure Drop (psi)	Shipping Weight (lbs)	Working Pressure (psi)	
		Min.	Max.			Shell Side	Tube Side
VSE-½	3	0.4	3.7	0.6	10	350	250
VSE-1	3.5	0.4	3.7	2.7	12	350	250
VSE-1½	9	0.6	5.9	3.4	28	350	250
VSE-2	11	0.6	5.9	7.0	29	350	250
VSE-3	9	1.2	12	3.3	26	350	250
VSE-5	15	1.8	18	4.5	45	350	250
VSE-7	29	2.4	24	5.6	83	350	250
VSE-10	80	3.0	30	7.6	146	350	250
VSE-10T	20	3.6	36	3.9	69	350	250
VSE-15T	36	4.7	47	5.9	130	350	250
VSE-20T	96	5.9	60	7.1	204	350	250

400 psi shell side on request

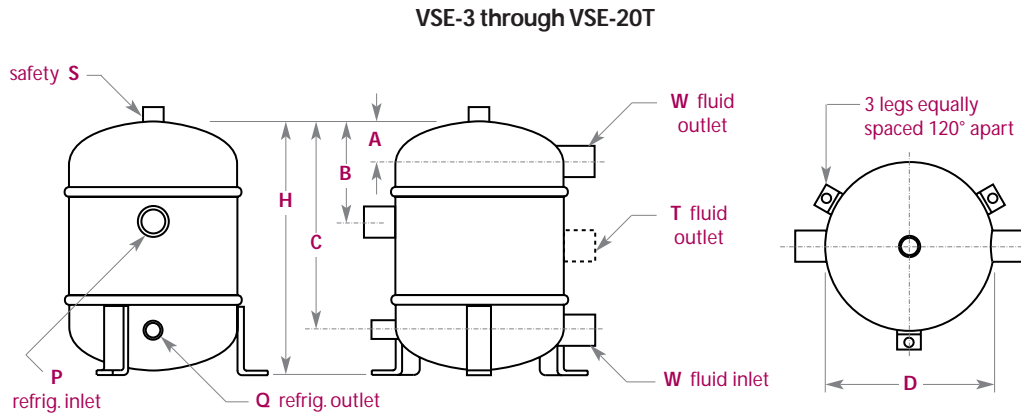



design features & ratings

- Specially designed removable water plates and gaskets allow unsurpassed ease of servicing or cleaning without disconnecting water or refrigerant lines
- All copper water channels
- Rugged steel construction to resist tubing damage
- Our smallest horizontal, tube in tube design
- Exceptional heat transfer utilizing enhanced tube surfaces
- Highest water pressure ratings, and lowest water pressure drop offered in a cleanable tube in tube condenser design
- 7 ELT models, up to 10 horsepower

NEW DESIGN!

MODELS	Nominal hp	Dimensions (inches)						Connections (inches)		
		D	L	H	A	B	C	P (ids)	Q (ids)	T (ids)
ELT-100A	1	2 7/8	21 1/2	11	16	4 1/4	5	5/8	1/2	7/8
ELT-150A	1 1/2	2 7/8	27 1/2	11	21 1/2	4 1/4	5	7/8	1/2	7/8
ELT-200A	2	2 7/8	27	12 5/8	21 1/2	4 1/4	5	7/8	1/2	7/8
ELT-300A	3	4 1/4	27	17 3/4	21 1/2	4 1/4	6	7/8	5/8	1 3/8
ELT-500A	5	4 1/4	27	17 3/4	21 1/2	4 1/4	6	7/8	7/8	1 3/8
ELT-800A	8	5 1/2	27 1/2	22 1/4	21 1/2	4 1/4	6	1 3/8	7/8	1 3/8
ELT-1000A	10	5 1/2	27 1/2	22 1/4	21 1/2	4 1/4	6 1/4	1 3/8	7/8	1 5/8

Nominal HP: As tested per ARI standard 450-99

MODELS	Waterflow (gpm)		Nom'l. Water Pressure Drop (psi)	Shipping Weight (lbs)	Working Pressure (psi)	
	Min.	Max.			Shell Side	Tube Side
ELT-100A	0.7	6.7	1.25	21	380	200
ELT-150A	0.7	6.7	2.99	23	380	200
ELT-200A	0.7	6.7	6.40	27	380	200
ELT-300A	1.3	13.4	4.34	48	380	200
ELT-500A	2.0	20.1	5.49	50	380	200
ELT-800A	3.4	33.5	5.09	85	380	200
ELT-1000A	4.0	40.2	5.46	90	380	200

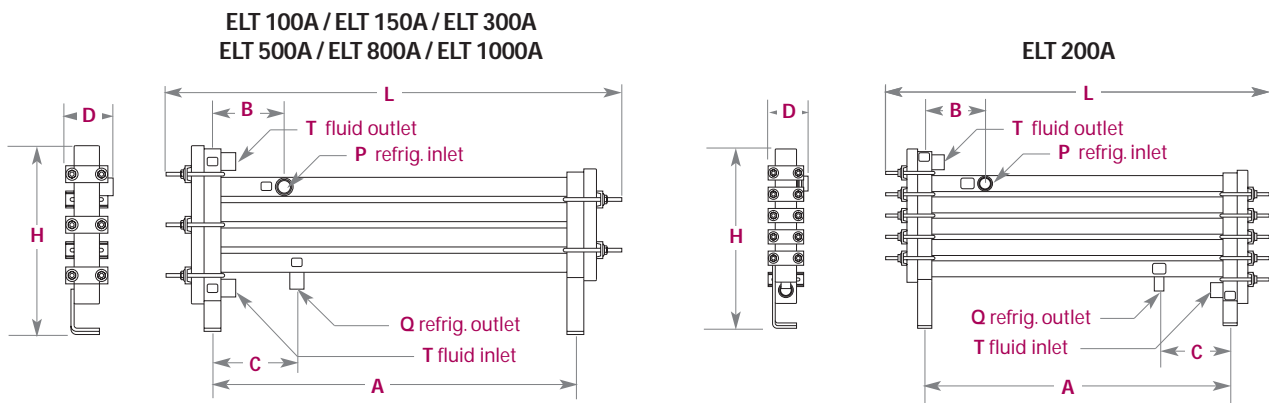

KHX

Heavy Duty Tube-in-Tube Condensers



design features & ratings

- Enhanced copper water tubes inside a series of four steel refrigerant tubes
- Ideal for replacement usage in narrow packages
- Threaded water connections for easy pipe fit-up
- Removable end plates allows access to remove mineral scale and sludge deposits
- 6 models, 1½ thru 10 horsepower

MODELS	Nominal hp	Dimensions (inches)				Connections (inches)		
		D	L	H	A	P (IDS)	Q (IDS)	T (FPT)
KH-1½X	1 ½	4 ¾	21 ¼	13 ½	16 ⅝	½	⅜	½
KH-2X	2	4 ¾	26 ⅜	13 ½	21	½	⅜	¾
KH-3X	3	4 ¾	32 ¾	13 ½	27	⅝	½	¾
KH-5X	5 ½	5	32 ⅜	16 ¼	27	⅞	⅝	1
KH-7½X	8	5 ½	35 ⅝	17 ¾	27	⅞	⅞	1 ¼
KH-10X	10 ½	5 ½	38 ⅝	17 ¾	33	1 ⅛	⅞	1 ¼

Nominal horsepower per ARI Standard 450-99
 ◇ Tubing has high performance extended surface

MODELS	Water Pressure Drop (psi)	Waterflow (gpm)		Shipping Weight (lbs)	Working Pressure (psi)	
		Min.	Max.		Shell Side	Tube Side
KH-1½X	1.0	2.5	13	45	420	150
KH-2X	2.2	2.5	13	50	420	150
KH-3X	5.0	5.5	13	60	420	150
KH-5X	7.0	6.0	20	90	420	150
KH-7½X	5.0	5.2	33	124	420	150
KH-10X	5.0	5.0	33	135	420	150

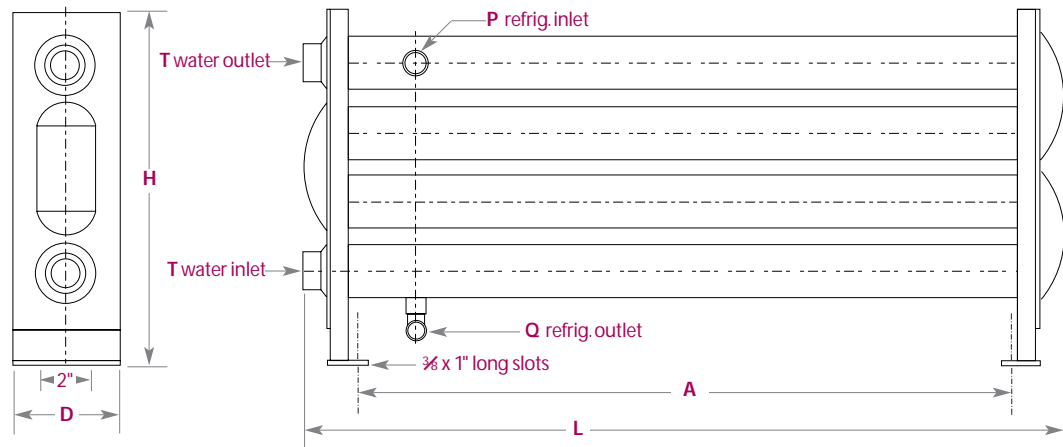



design features & ratings

MODELS	Nominal hp		Dimensions (inches)							Connections (inches)			
	clean	fouled	D	L	A	B	E	F	R	P (ids)	Q (ids)	S (fpt)	T (fpt)
MSE-100	1.3	1.0	6	21 5/8	1 5/8	16 3/8	1 7/8	2	1 5/8	5/8	1/2	3/8	1/2
MSE-200	2.6	2.0	6	21 5/8	1 5/8	16 3/8	1 7/8	2	1 5/8	7/8	5/8	3/8	1/2
MSE-300	4.6	3.3	6 5/8	21 3/4	2	16	1	2	1 3/4	7/8	5/8	3/8	3/4
MSE-500	6.0	4.6	6 5/8	21 3/4	2 1/8	16	1	2	1 3/4	1 1/8	5/8	3/8	3/4
MSE-750	9.5	6.7	6 5/8	34 1/4	2	28	2	2 1/4	2	1 3/8	7/8	3/8	1 1/4
MSE-1005	11.7	9.5	6 5/8	40 1/4	2	33	2	2 1/4	2	1 3/8	7/8	3/8	1 1/4
MSE-1500	19.9	15.8	8 5/8	40 1/4	2 1/2	33 1/2	2 1/8	2	2 1/4	1 5/8	1 1/8	1/2	2
MSE-2005	26.7	20.2	8 5/8	64 1/2	3	57	2 1/8	2 1/4	2 1/4	2 1/8	1 1/8	1/2	2
MSE-2505	33.1	25.9	8 5/8	64 1/2	3	57	2 1/8	2 1/4	2 1/4	2 1/8	1 3/8	1/2	2
MSE-3006	39.7	31.6	8 5/8	76 1/2	3	69	2	2 1/4	2 1/4	2 5/8	1 3/8	1/2	2 1/2
MSE-3305	44.4	32.6	10 3/4	65	3	56 1/2	2 1/8	2 3/4	2 1/4	2 5/8	1 3/8	1/2	2 1/2
MSE-4005	45.8	33.6	10 3/4	65	3	56 1/2	2 1/8	2 3/4	2 1/4	2 5/8	1 5/8	1/2	2 1/2
MSE-4505	57.7	44.2	10 3/4	77	3	68 1/2	2 1/8	2 3/4	2 1/4	2 5/8	1 5/8	1/2	2 1/2
MSE-5005	59.6	45.7	10 3/4	77	3	68 1/2	2 1/8	2 3/4	2 1/4	2 5/8	1 5/8	1/2	2 1/2
MSE-6505	71.0	58.2	12 3/4	78 3/4	3 1/2	68 1/2	2 3/4	4 1/4	2 3/8	3 1/8	2 1/8	1/2	4
MSE-7505	84.8	66.1	12 3/4	78 3/4	3 1/2	68 1/2	2 3/4	4 1/4	2 3/8	3 1/8	2 1/8	1/2	4
MSE-100HP	132.2	99.8	12 3/4	133 1/2	3 1/2	116 1/2	—	6 5/8	6 5/8	3 1/8	2 1/8	1/2	5 mpt
MSE-120HP	137.2	103.6	12 3/4	133 1/2	3 1/2	115 3/4	—	6 5/8	6 5/8	3 5/8	2 1/8	1/2	5 mpt

† Tubing has high performance extended surface

Zinc plates are available for all MSE models. Indicate by adding "Z" after model number (MSE-750Z)

Clean ratings: As tested per ARI standard 450-99.

Fouled ratings: Include fouling factor coefficient of 0.00025 as calculated per ARI standard 450-99.

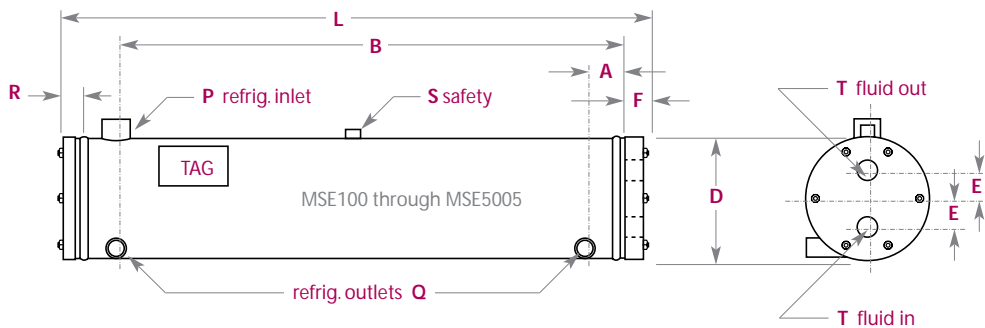

- Marine service
- Heavy duty, horizontal, shell and tube design
- Nominal ratings and sizes to handle the most demanding requirements
- Epoxy coated solid cupronickel tube sheets to prevent pitting caused by galvanic action
- Removable, cupronickel clad or solid brass water plates to facilitate cleaning

- All 90/10 cupronickel, heavy wall, straight tube water channels
- Sacrificial zinc anode available upon request
- Generous pumpdown capacities
- Dual refrigerant outlets, provides liquid seal in heavy seas
- Custom designs to 500 horsepower on request
- 18 MSE stock models, 1 to 125 horsepower

MODELS	Pumpdown Capacity (lbs)	Waterflow (gpm)		Water Pressure Drop (psi)	Shipping Weight (lbs)	Working Pressure (psi)	
		Min.	Max.			Shell Side	Tube Side
MSE-100	14	0.74	7.38	3.0	35	400	150
MSE-200	12	1.48	14.77	3.0	49	400	150
MSE-300	14	1.66	16.61	6.9	58	400	150
MSE-500	15	2.22	22.15	7.6	77	400	150
MSE-750	24	4.43	44.30	2.3	107	400	150
MSE-1005	29	4.43	44.30	5.4	121	400	150
MSE-1500	49	7.38	73.84	5.4	181	400	150
MSE-2005	86	13.29	123.90	2.5	254	400	150
MSE-2505	79	16.24	162.44	2.9	265	400	150
MSE-3006	99	14.77	147.67	5.7	286	400	150
MSE-3305	133	20.67	206.74	2.8	338	400	150
MSE-4005	129	22.15	221.51	2.5	343	400	150
MSE-4505	160	20.67	206.74	5.7	388	400	150
MSE-5005	155	22.15	221.51	5.0	394	400	150
MSE-6505	225	28.80	287.96	3.1	517	400	125
MSE-7505	215	32.49	324.88	3.2	533	400	125
MSE-100HP	358	64.98	500.00	1.3	1133	400	125
MSE-120HP	344	70.88	708.82	1.1	1158	400	125

† Tubing has high performance extended surface

Zinc plates are available for all MSE models. Indicate by adding "Z" after model number (MSE-750Z)

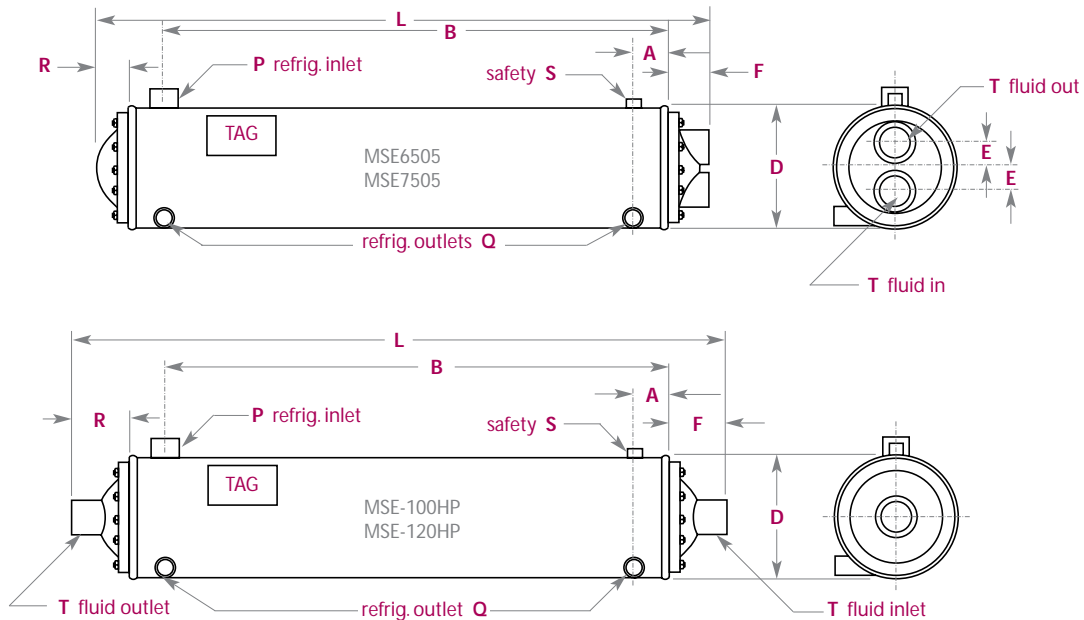

SCH SCS

Coaxial Style Water Cooled Condensers



design features & ratings

- High efficiency counterflow design
- Ideal for domestic heat pumps, and water coolers
- Replacement models for most manufactures
- Copper and 90/10 Cupronickel tube models stocked
- UL and CSA listed
- 18 coaxial models from, 1/3 to 7 hp

MODELS	Nom'l hp	Dimensions (inches)								Connections		Ship Wt. (lbs)
		A	B	C	D	E	G	H	J	Refrig. R (ods)	Fluid F (ods)	
SCH-04	.33	1.25	4.00	5.75	6.75	9.25	2.50	5.63	.375	.375	.625	5
SCH-06	.50	1.31	5.06	5.75	6.75	9.25	2.50	5.63	.375	.375	.625	8
SCH-09	.75	1.31	6.19	5.88	6.75	9.25	2.50	6.75	.375	.375	.625	9
SCH-12	1.00	1.41	7.28	5.88	6.75	9.25	2.50	7.94	.375	.375	.625	12
SCH-18	1.50	1.31	5.19	11.50	12.50	13.00	6.00	5.88	.500	.500	.625	16
SCS-24	2.00	4.75	3.38	10.00	12.75	14.00	6.00	5.50	.500	.500	.750	25
SCS-30	2.50	4.56	4.00	10.00	12.75	14.00	6.00	5.38	.500	.500	.750	31
SCS-36	3.00	5.00	4.75	11.25	14.50	15.38	6.00	6.50	.500	.625	.875	35
SCS-42	3.50	4.75	4.63	12.50	15.50	16.00	6.00	5.75	.500	.625	.875	37
SCS-48	4.00	6.00	5.13	14.50	17.75	18.50	6.00	6.88	.500	.875	1.125	55
SCS-60	5.00	6.75	5.75	14.63	18.00	19.00	6.00	7.63	.500	.875	1.125	59
SCS-84	7.00	8.13	6.00	15.50	20.50	22.50	6.00	9.63	.500	.875	1.375	75

Cupronickel MODELS	Nom'l hp	Dimensions (inches)								Connections		Ship Wt. (lbs)	Working Pressure (psi)	
		A	B	C	D	E	G	H	J	Refrig. R (ods)	Fluid F (ods)		Shell	Tube
SCH-12CN	1.00	1.41	7.28	5.88	6.75	9.25	2.50	7.94	.375	.375	.625	12	450	350
SCH-18CN	1.50	1.31	5.19	11.50	12.50	13.00	6.00	5.88	.500	.500	.750	16	450	350
SCS-24CN	2.00	4.75	3.38	10.00	12.75	14.00	6.00	5.50	.500	.500	.750	25	450	350
SCS-36CN	3.00	5.00	4.75	11.25	14.50	15.38	6.00	6.50	.500	.625	.875	35	450	350
SCS-48CN	4.00	6.00	5.13	14.50	17.75	18.50	6.00	6.88	.500	.875	1.125	55	450	350
SCS-60CN	5.00	6.75	5.75	14.63	18.00	19.00	6.00	7.63	.500	.875	1.125	59	450	350

Nominal HP ratings as per ARI standard 450-99

Helix SCH models

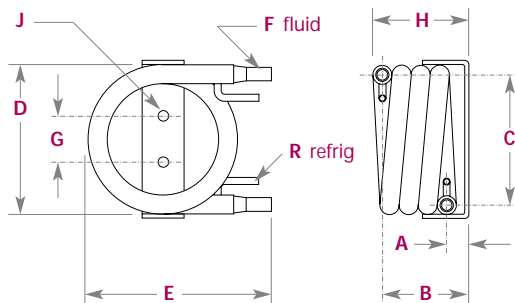

Spiral SCS models

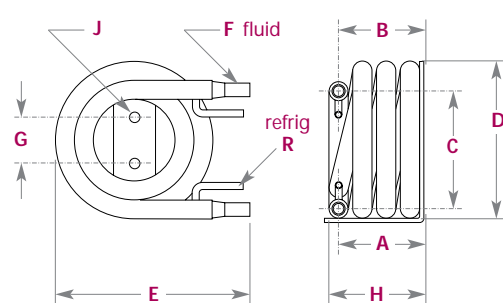

Gasket & Endplates Cross Reference

Condenser	Front Gasket GASKE--	Rear Gasket GASKE--	Front Endplate ENDPL--	Rear Endplate ENDPL--
SST 75A	3156	346	4304	30
*SST 75	337	346	49	30
SST 100A	3163	3149	5040	5026
*SST 100	175	184	67	58
*SST 150	175	184	67	58
SST 200A	3101	3170	5819	76
*SST 200	193	201	85	76
SST 300A	3101	3170	5819	76
*SST 300	193	201	85	76
SST 500A	3118	2584	5938	4047
*SST 500	210	229	120	21
SST 750A	3118	2584	5938	4047
*SST 750	210	229	12	21
SST 755A	3118	2584	5938	4047
*SST 755	238	247	12	21
SST 1000A	1723	2953	6605	4047
*SST 1000	238	247	12	21
SST 1500A	1723	2953	5576	4047
*SST 1501	2977	2584	175	4047
SST 1555A	2591	2984	5907	4180
*SST 1555	256	265	193	184
SST 2005A	2591	2984	5914	4180
*SST 2005	256	265	148	184
SST 2026A	2591	2984	5914	4180
*SST 2026	256	265	148	184
SST 2505A	2591	2984	6205	4180
*SST 2505	256	265	148	184
SST 2527A	2591	2984	6205	4180
*SST 2527	256	265	148	184
SST 3005A	2591	2984	6205	4180
*SST 3005	256	265	148	184
SST 3028A	2591	2984	6205	4180
*SST 3028	256	265	148	184
*SST 30-460M	166	111	166	157
SST 3505A	2591	2984	6205	4180
*SST 35-520M	166	111	201	157
SST 4005A	111	120	210	238
*SST 40-610M	111	120	210	238
SST 4505A	111	120	210	238
*SST 45-680M	111	120	210	238
SST 5005A	111	120	247	238
*SST 50-760M	111	120	210	238
SST 5505A	111	120	247	238
*SST 55-850M	111	120	210	238
SST 6005A	111	120	247	238
*SST 60-940M	111	120	247	238
SST 7005A	111	120	247	238
*SST 70-1060M	111	120	247	238
SST 8005A	111	120	247	238
*SST 80-1200M	111	120	247	238
SST 100-1408A	120	120	2245	2245
*SST 100-1500M	111	120	247	238
SST 120-1408A	120	120	2245	2245
*SST 126-1905M	120	120	3994	3994

Condenser	Front Gasket GASKE--	Rear Gasket GASKE--	Front Endplate ENDPL--	Rear Endplate ENDPL--
SST 150-1410A	120	120	2245	2245
*SST 150-2250M	2254	2254	'H1039	'H1039
SST 200-1412A	120	120	4335	4335
*SST 200-3000M	2263	2263	'H1048	'H1048
*SST 250-3750M	1679	1679	'H1057	'H1057
*SST 300-4500M	1688	1688	'H1066	'H1066
*SST 350-5250M	1688	1688	'H1066	'H1066
*SST 400-6000M	2290	2290	'H1921	'H1921
*SST 500-7500M	2290	2290	'H1921	'H1921
HSE 2	337	346	6412	30
HSE 3	175	184	6717	5026
HSE 5	3718	3170	6229	76
HSE 7	3718	3170	5552	76
HSE 10	3718	3170	5552	76
HSE 15	445	247	5495	21
HSE 20A	2953	2584	5707	4047
*HSE 20	1723	1732	2227	21
HSE 25A	2953	2584	5707	4047
*HSE 25	1723	1732	2227	21
HSE 30A	1741	2984	5583	4180
*HSE 30	1741	1750	2236	4180
HSE 40A	1741	2984	5464	4180
*HSE 40	1741	1750	2236	4180
HSE 50A	1741	2984	5464	4180
*HSE 50	1741	1750	2236	4180
HSE 60	111	120	247	238
HSE 70	111	120	247	238
HSE 80	111	120	247	238
HSE 100	120	120	2245	2245
HSE 125	120	120	2245	2245
HSE 150	2254	2254	'H1039	'H1039
HSE 200	2263	2263	'H1048	'H1048
HSE 250	1679	1679	'H1057	'H1057
HSE 300	1688	1688	'H1066	'H1066
HSE 350	1688	1688	'H1066	'H1066
HSE 400	2290	2290	'H1921	'H1921
HSE 450	2290	2290	'H1921	'H1921
HSE 500	2290	2290	'H1921	'H1921
HP 10		Call Factory		
HP 15		Call Factory		
HP 20		Call Factory		
HP 30		Call Factory		
HP 40		Call Factory		
HP 50		Call Factory		
HP 60		Call Factory		
HP 80		Call Factory		
CA 050	355	364	2876	2885
CA 075	238	247	2911	2902
CA 100	238	247	2911	2902
CA 150	256	265	2920	2948
CA 200	445	247	2894	2902
CA 300	373	265	2939	2948









This chart is to be used for reference purposes only.
For replacement parts contact customer service with your condenser model and serial numbers.

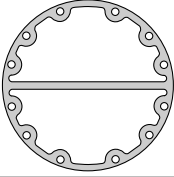
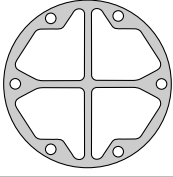
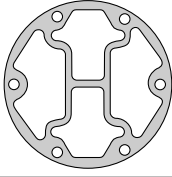
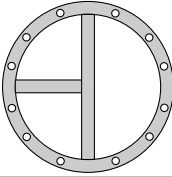
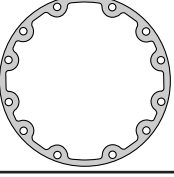
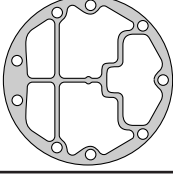

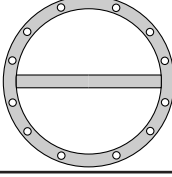
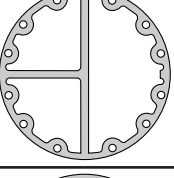
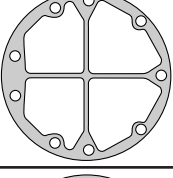

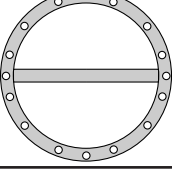
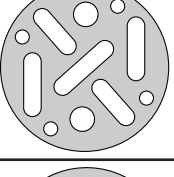
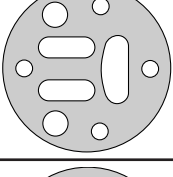
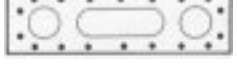
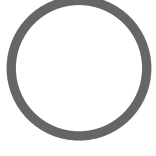
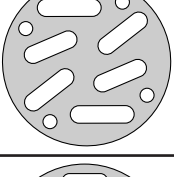
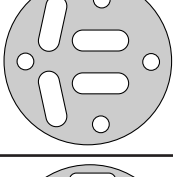

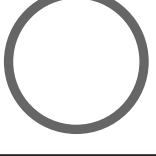
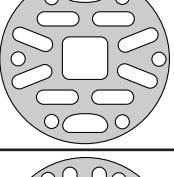
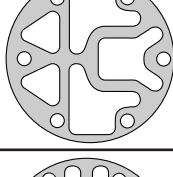
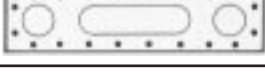
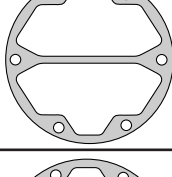
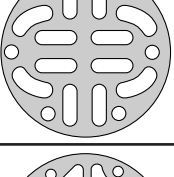
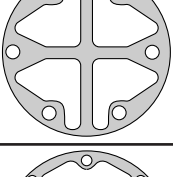

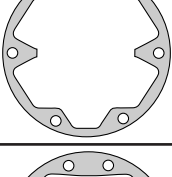
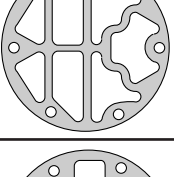
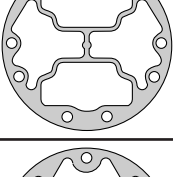
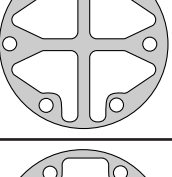
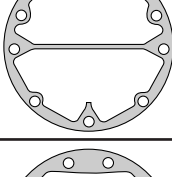
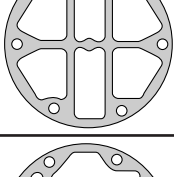
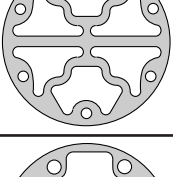
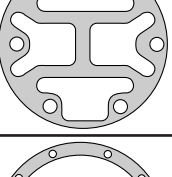
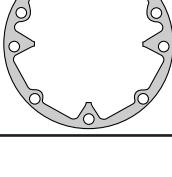
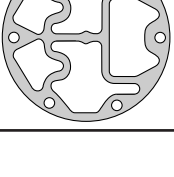
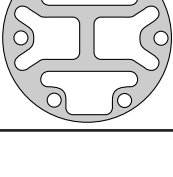
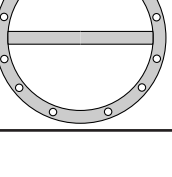

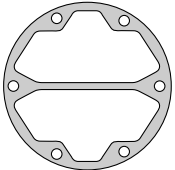
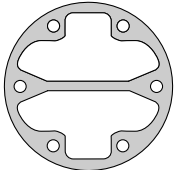
* Indicates that model is obsolete and no longer manufactured. • H prefix indicates 'Head' (flange) style endplate.

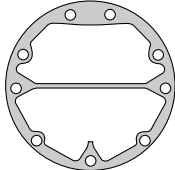
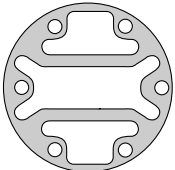
Condenser	Front Gasket GASKE--	Rear Gasket GASKE--	Front Endplate ENDPL--	Rear Endplate ENDPL--
MSE 100	3163	3149	6436	300
MSE 200	3163	3149	6436	300
MSE 300	355	364	6386	337
MSE 500	355	364	6386	337
MSE 750	436	364	6281	4461
MSE 1005		Call Factory		
MSE 1500	445	2584	5752	4104
MSE 2005	1723	2953	5752	4104
MSE 2505	1723	2953	5752	4104
MSE 3006	1723	2953	6467	4104
MSE 3305	1741	2984	6481	5114
MSE 4005	1741	2984	6481	5114
MSE 4505	1741	2984	6481	5114
MSE 5005	1741	2984	6481	5114
MSE 6505	111	120	2542	5233
MSE 7505	111	120	2542	5233
MSE 100Hp	4092	4092	120	120
MSE 120Hp	4092	4092	120	120
*MS 100	175	184	328	300
*MS 150	175	184	328	300
*MS 200	355	364	2452	337
*MS 300	355	364	2452	337
*MS 500	382	229	2461	355
*MS 750	382	229	2470	355
*MS 755	445	247	3334	355
*MS 1000	445	247	3334	355
*MS 1500	445	247	2489	355
*MS 1501	1723	2953	2489	4104
*MS 1555	373	265	2498	373
*MS 2005	373	265	2506	373
*MS 2026	373	265	2506	373
*MS 2505	373	265	2506	373
*MS 2527	373	265	2506	373
*MS 3005	373	265	2506	373
*MS 3028	373	265	2506	373
*MS 30 460M	166	111	2524	2597
*MS 35 520M	166	111	2524	2597
*MS 40 610M	111	120	2533	2605
*MS 45 680M	111	120	2533	2605
*MS 50 760M	111	120	2533	2605
*MS 55 850M	111	120	2533	2605
*MS 60 940M	111	120	2533	2605
*MS 70 1060M	111	120	2542	2605
*MS 80 1200M	111	120	2542	2605
*MS 100 1500M	111	120	2542	2605
*MS 120 1901M	120	120	4092	4092
*MS 125 1900M	111	120	2542	2605
	(MSE Units with Zinc Anode)			
*MS 100Z	175	184	328	4454
*MS 150Z	175	184	328	4454
*MS 200Z	355	364	2452	4461
*MS 300Z	355	364	2452	4461
*MS 500Z	382	229	2461	4478
*MS 750Z	382	229	2470	4478
*MS 755Z	445	247	3334	4478
*MS 1000Z	445	247	3334	4478
*MS 1501Z	1723	2953	2489	4485
*MS 1555Z	373	265	2498	4492
*MS 2005Z	373	265	2506	4492
*MS 2026Z	373	265	2506	4492
*MS 2505Z	373	265	2506	4492
*MS 2527Z	373	265	2506	4492

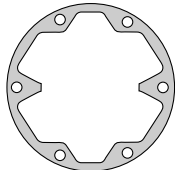
	Front Gasket GASKE--	Rear Gasket GASKE--	Front Endplate ENDPL--	Rear Endplate ENDPL--
*MS 3005Z	373	265	2506	4492
*MS 3028Z	373	265	2506	4492
*SM 3	355	364	2452	337
*SM 5	445	247	3956	355
*SM 7	445	247	3334	355
*SM 10	445	247	3334	355
*SM 15	445	247	2489	355
*SM 20	445	247	3918	355
*SM 21S	373	265	2506	373
*SM 25	445	247	3918	355
*SM 26S	166	111	2524	2597
*SM 30	445	247	3918	355
*SM 31S	166	111	2524	2597
*SM 35	373	265	3901	373
*SM 36S	166	111	2524	2597
*SM 40	373	265	3901	373
*SM 50	111	120	2533	2605
*SM 60	111	120	3868	2605
*SM 70	111	120	2542	2605
ELT 100A	5057	5064	3055	3073
ELT 150A	5057	5064	3055	3073
ELT 200A	5057	5057	3055	3154
ELT 300A	2191	2209	3253	3280
ELT 500A	2191	2209	3253	3280
ELT 800A	2461	2470	3451	3482
ELT 1000A	2461	2470	3451	3482
*ELT 50	2092	2100	3046	3064
*ELT 75	2092	2100	3046	3064
*ELT 100	2092	2100	3046	3064
*ELT 150	2092	2100	3046	3064
*ELT 200	2092	2092	3424	3424
*ELT 300	2191	2209	3262	3280
*ELT 500	2191	2209	3262	3280
*ELT 800	2461	2470	3475	3482
*ELT 1000	2461	2470	3475	3482
TNT 50	2074	2083	2993	3028
TNT 75	2074	2083	2993	3028
TNT 100	2074	2083	2993	3028
TNT 150	2092	2100	3046	3064
TNT 200	2092	2100	3046	3064
KH 1 1/2 X	698A	698B	1840	1796
KH 2X	698A	698B	1840	1796
KH 3X	698A	698B	1840	1796
KH 5X	706A	706B	1859	1813
KH 7 1/2 X	724A	724B	1868	1831
KH 10X	724A	724B	1868	1831
*SWT 50	2092	2092	4061	4061
*SWT 75	2092	2092	4061	4061
*SWT 100	2092	2092	4061	4061
*SWT 150	2092	2092	4061	4061
*SWT 200	2191	2191	4078	4078
*SWT 300	2191	2191	4078	4078
*SWT 500	2191	2191	4078	4078

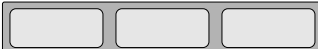
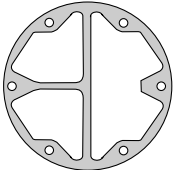
Condenser Gasket ID

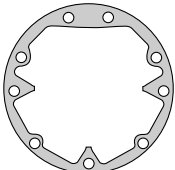
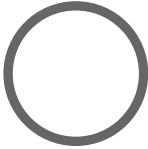
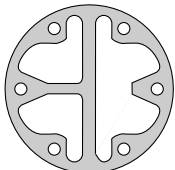
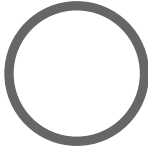
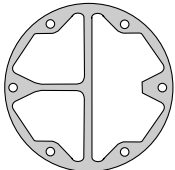
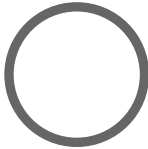
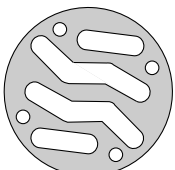
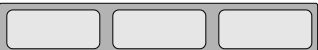
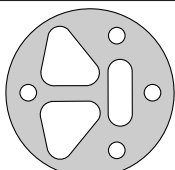
<p>111 12 3/4" Dia. 12 Studs</p> 	<p>247 8 5/8" Dia. 6 Studs</p> 	<p>445 8 5/8" Dia. 6 Studs</p> 	<p>1471 8 5/8" Dia. 12 Studs</p> 
<p>120 12 3/4" Dia. 12 Studs</p> 	<p>256 10 3/4" Dia. 9 Studs</p> 	<p>698A</p> 	<p>1480 12 3/4" Dia. 12 Studs</p> 
<p>166 12 3/4" Dia. 12 Studs</p> 	<p>265 10 3/4" Dia. 9 Studs</p> 	<p>698B</p> 	<p>1499 14" Dia. 12 Studs</p> 
<p>175 6" Dia. 4 Studs</p> 	<p>337 5" Dia. 4 Studs</p> 	<p>706A</p> 	<p>1679 19 11/16" Dia.</p> 
<p>184 6" Dia. 4 Studs</p> 	<p>346 5" Dia. 4 Studs</p> 	<p>706B</p> 	<p>1688 21 11/16" Dia.</p> 
<p>193 6 5/8" Dia. 6 Studs</p> 	<p>355 6 5/8" Dia. 6 Studs</p> 	<p>724A</p> 	<p>1723 8 5/8" Dia. 6 Studs</p> 
<p>201 6 5/8" Dia. 6 Studs</p> 	<p>364 6 5/8" Dia. 6 Studs</p> 	<p>724B</p> 	<p>1732 8 5/8" Dia. 6 Studs</p> 
<p>210 8 5/8" Dia. 6 Studs</p> 	<p>373 10 3/4" Dia. 9 Studs</p> 	<p>1057 6 5/8" Dia. 6 Studs</p> 	<p>1741 10 3/4" Dia. 9 Studs</p> 
<p>229 8 5/8" Dia. 6 Studs</p> 	<p>382 8 5/8" Dia. 6 Studs</p> 	<p>1066 6 5/8" Dia. 6 Studs</p> 	<p>1750 10 3/4" Dia. 9 Studs</p> 
<p>238 8 5/8" Dia. 6 Studs</p> 	<p>436 6 5/8" Dia. 6 Studs</p> 	<p>1462 10 3/4" Dia. 12 Studs</p> 	<p>2074 tube-in-tube gasket No picture available</p>

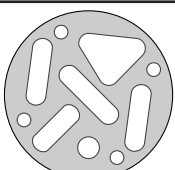
<p>2083 tube-in-tube gasket No picture available</p>	<p>2584 8 5/8" Dia. 6 Studs</p> 	<p>3170 6 5/8" Dia. 6 Studs</p> 	
<p>2092 1 3/16" x 9 1/16"</p> 	<p>2591 10 3/4" Dia. 9 Studs</p> 	<p>3718 6 5/8" Dia. 6 Studs</p> 	
<p>2100 1 3/16" x 6 5/16"</p> 	<p>2953 8 5/8" Dia. 6 Studs</p> 	<p>5057 1 3/16" x 9 1/16"</p> 	
<p>2191 2 9/16" x 15 3/4" Dia.</p> 	<p>2977 8 5/8" Dia. 6 Studs</p> 		
<p>2209 2 9/16" x 15 3/4" Dia.</p> 	<p>2984 10 3/4" Dia. 9 Studs</p> 		
<p>2254 14 11/16" Dia.</p> 	<p>3101 6 5/8" Dia. 6 Studs</p> 		
<p>2263 16 11/16" Dia.</p> 	<p>3118 8 5/8" Dia. 6 Studs</p> 		
<p>2290 25" Dia.</p> 	<p>3149 6" Dia. 4 Studs</p> 		
<p>2461 3 1/4" x 20 1/4" Dia.</p> 	<p>3156 5" Dia. 4 Studs</p> 		
<p>2470 3 1/4" x 13 1/2" Dia.</p> 	<p>3163 6" Dia. 4 Studs</p> 		

Condenser Front Endplate ID

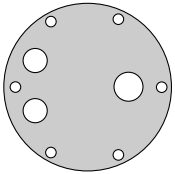
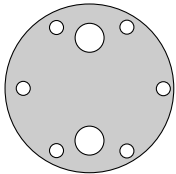
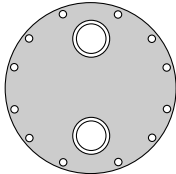
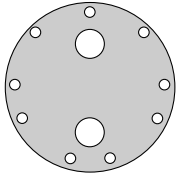
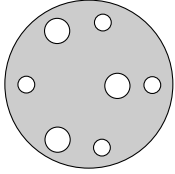
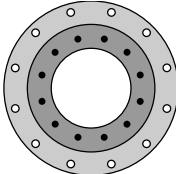
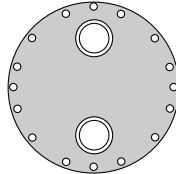
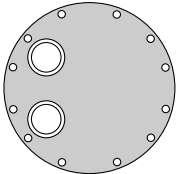
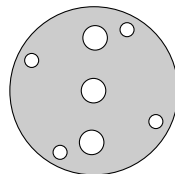
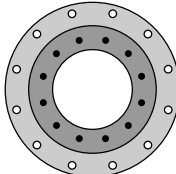
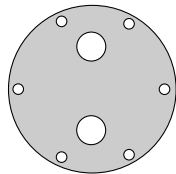
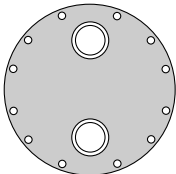
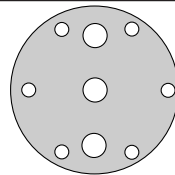
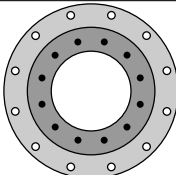
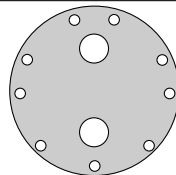
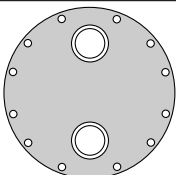
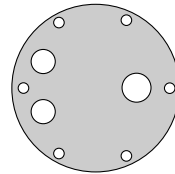
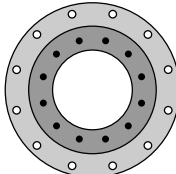
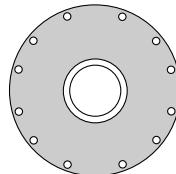
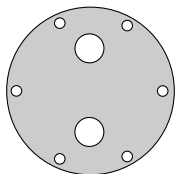
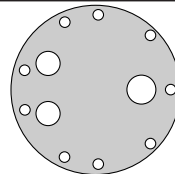
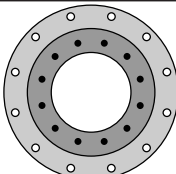
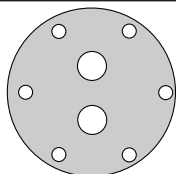
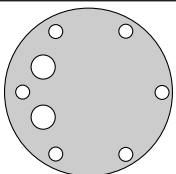
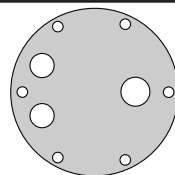
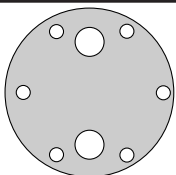
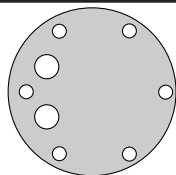
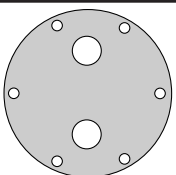
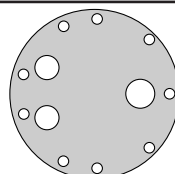
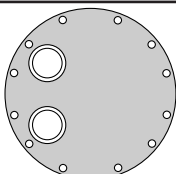
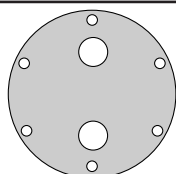
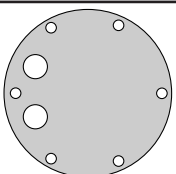
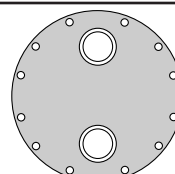
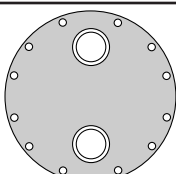
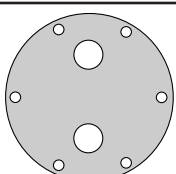
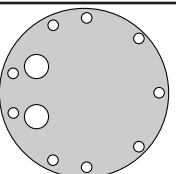
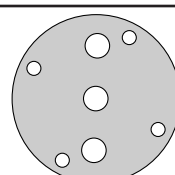
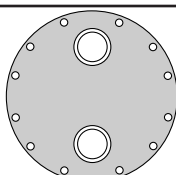
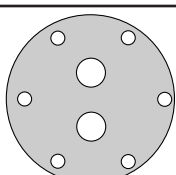
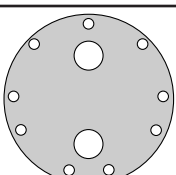
<p>12</p> <p>8 1/2" Dia. 6 Studs</p> 	<p>706</p> <p>6 5/8" Dia. 6 Studs</p> 	<p>2137</p> <p>12 3/4" Dia. 12 Studs</p> 	<p>2506</p> <p>10 3/4" Dia. 9 Studs</p> 
<p>49</p> <p>5" Dia. 4 Studs</p> 	<p>H1039</p> <p>17 7/8" Dia.</p> 	<p>2155</p> <p>14" Dia. 16 Studs</p> 	<p>2524</p> <p>12 3/4" Dia. 12 Studs</p> 
<p>67</p> <p>6" Dia. 4 Studs</p> 	<p>H1048</p> <p>19 7/8" Dia.</p> 	<p>2227</p> <p>8 5/8" Dia. 6 Studs</p> 	<p>2533</p> <p>12 3/4" Dia. 12 Studs</p> 
<p>85</p> <p>6 5/8" Dia. 6 Studs</p> 	<p>H1057</p> <p>22" Dia.</p> 	<p>2236</p> <p>10 3/4" Dia. 9 Studs</p> 	<p>2542</p> <p>12 3/4" Dia. 12 Studs</p> 
<p>120</p> <p>8 5/8" Dia. 6 Studs</p> 	<p>H1066</p> <p>24" Dia.</p> 	<p>2245</p> <p>12 3/4" Dia. 12 Studs</p> 	<p>2678</p> <p>8 5/8" Dia. 6 Studs</p> 
<p>148</p> <p>10 3/4" Dia. 9 Studs</p> 	<p>H1921</p> <p>28" Dia.</p> 	<p>2263</p> <p>8 5/8" Dia. 6 Studs</p> 	<p>2876</p> <p>6 5/8" Dia. 6 Studs</p> 
<p>175</p> <p>8 5/8" Dia. 6 Studs</p> 	<p>1499</p> <p>6 5/8" Dia. 6 Studs</p> 	<p>2452</p> <p>6 5/8" Dia. 6 Studs</p> 	<p>2894</p> <p>8 5/8" Dia. 6 Studs</p> 
<p>193</p> <p>10 3/4" Dia. 9 Studs</p> 	<p>2065</p> <p>8 5/8" Dia. 12 Studs</p> 	<p>2461</p> <p>8 5/8" Dia. 6 Studs</p> 	<p>2911</p> <p>8 5/8" Dia. 6 Studs</p> 
<p>247</p> <p>12 3/4" Dia. 12 Studs</p> 	<p>2092</p> <p>8 5/8" Dia. 12 Studs</p> 	<p>2470</p> <p>8 5/8" Dia. 6 Studs</p> 	<p>2920</p> <p>10 3/4" Dia. 9 Studs</p> 
<p>328</p> <p>6" Dia. 4 Studs</p> 	<p>2119</p> <p>10 3/4" Dia. 12 Studs</p> 	<p>2489</p> <p>8 5/8" Dia. 6 Studs</p> 	<p>2939</p> <p>10 3/4" Dia. 9 Studs</p> 

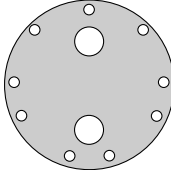
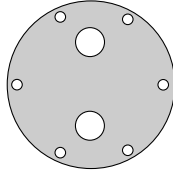
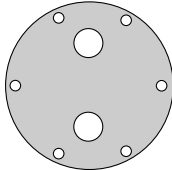
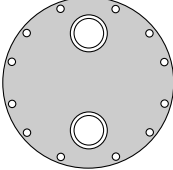
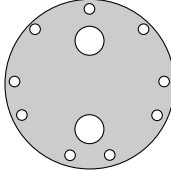
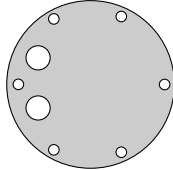
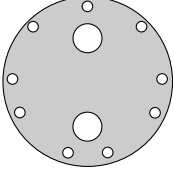
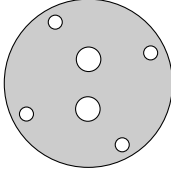
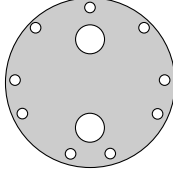
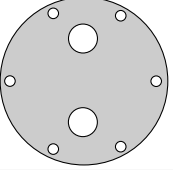
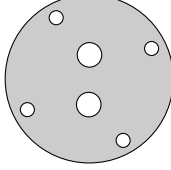
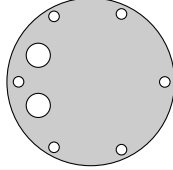
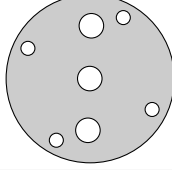
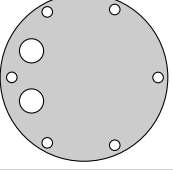
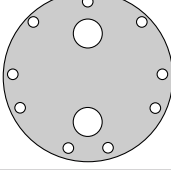
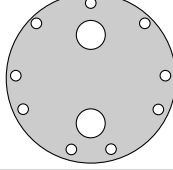
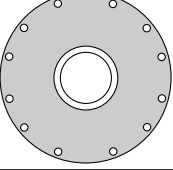
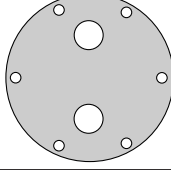
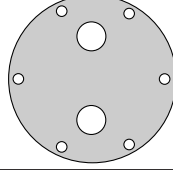
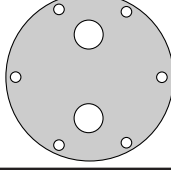
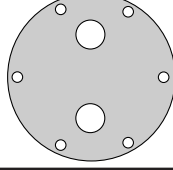
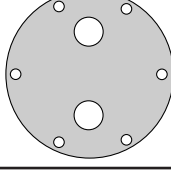
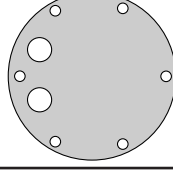
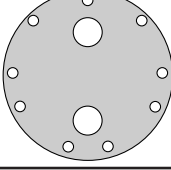
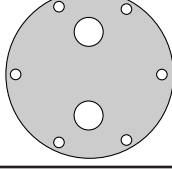
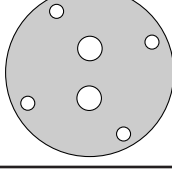
<p>3334</p> <p>8 5/8" Dia. 6 Studs</p> 	<p>4278</p> <p>10 3/4" Dia. 9 Studs</p> 	<p>5752</p> <p>8-5/8" Dia. 6 Studs</p> 	<p>6467</p> <p>8-5/8" Dia. 6 Studs</p> 
<p>3868</p> <p>12 3/4" Dia. 12 Studs</p> 	<p>4292</p> <p>10 3/4" Dia. 9 Studs</p> 	<p>5819</p> <p>6-3/4" Dia. 6 Studs</p> 	<p>6481</p> <p>10-3/4" Dia. 9 Studs</p> 
<p>3901</p> <p>10 3/4" Dia. 9 Studs</p> 	<p>4328</p> <p>6" Dia. 4 Studs</p> 	<p>5907</p> <p>10-3/4" Dia. 9 Studs</p> 	<p>6605</p> <p>8-5/8" Dia. 6 Studs</p> 
<p>3918</p> <p>8 5/8" Dia. 6 Studs</p> 	<p>5040</p> <p>6" Dia. 4 Studs</p> 	<p>5938</p> <p>8-5/8" Dia. 6 Studs</p> 	<p>6717</p> <p>6" Dia. 4 Studs</p> 
<p>3956</p> <p>8 5/8" Dia. 6 Studs</p> 	<p>5464</p> <p>10-3/4" Dia. 9 Studs</p> 	<p>6205</p> <p>10-3/4" Dia. 9 Studs</p> 	
<p>4092</p> <p>12 3/4" Dia. 12 Studs</p> 	<p>5495</p> <p>8-5/8" Dia. 6 Studs</p> 	<p>6229</p> <p>6-3/4" Dia. 6 Studs</p> 	
<p>4230</p> <p>6 5/8" Dia. 6 Studs</p> 	<p>5552</p> <p>6-3/4" Dia. 6 Studs</p> 	<p>6281</p> <p>6-5/8" Dia. 6 Studs</p> 	
<p>4247</p> <p>8 5/8" Dia. 6 Studs</p> 	<p>5576</p> <p>8-5/8" Dia. 6 Studs</p> 	<p>6386</p> <p>6-5/8" Dia. 6 Studs</p> 	
<p>4254</p> <p>8 5/8" Dia. 6 Studs</p> 	<p>5583</p> <p>10-3/4" Dia. 9 Studs</p> 	<p>6412</p> <p>5" Dia. 4 Studs</p> 	
<p>4261</p> <p>10 3/4" Dia. 9 Studs</p> 	<p>5707</p> <p>8-5/8" Dia. 6 Studs</p> 	<p>6436</p> <p>6" Dia. 4 Studs</p> 	

Chiller Barrel Sizing

Selecting the proper chiller barrel for your application depends on four basic sizing considerations:

Range

The desired temperature drop of the fluid measured as the difference between incoming and outgoing fluid temperatures.

Approach

The desired temperature difference between outgoing fluid and the refrigerant evaporating temperature.

Pressure Drop

Acceptable level of fluid pressure drop through the chiller barrel at computed gallons per minute (gpm) flow rate.

Capacity

Necessary heat removal (tonnage) at maximum operating load

After determining fluid temperature drop (Range), find the capacity table identified for the particular range. (If no table exists for that specific point, use the next lowest temperature range for which a table exists.) At the top of the table, various approach temperatures are given. Find the approach desired and read down the tons column until you reach a capacity adequate to do the job. The water pressure drop (psi) is listed next to the capacity figure. To determine gpm, multiply tons by the gpm factor, which is noted below each range chart.

Chiller barrels may be sized by other methods as well. Where the desired temperature range is known (difference between incoming and outgoing fluid), determine the Btu/hr capacity needed by multiplying the temperature range by gpm flow and convert to pounds of water per hour using the multiplier 500.

$$\text{Range} \times \text{gpm} \times 500 = \text{Btu/hr}$$

Another sizing method is by compressor capacity. Manufacturer curves showing compressor Btu/hr values serve as a simple guideline for selecting chiller barrels for a given system.

Also, Standard chiller barrels are rated to ARI standards and can be selected on a nominal system tons basis using the capacity charts in this catalog. This method, however, is recommended only for high temperature (air conditioning) systems.

Water Nozzle Location

The standard water nozzle location is on the right as you are facing the refrigerant connections. Special top, and left side connections can be ordered.

Technical Assistance and Custom Designs

Standard offers custom design services and computer performance projections on all heat exchange products to help you match product and application accurately. You are invited to contact your nearest sales representative or our office headquarters for prompt assistance.

Chiller Barrels



design features & ratings

Conformance

Standard chiller barrels 6" and smaller OD shell are U.L. listed for 225 psi tube side and 225 psi shell side working pressures.

Units with 6 5/8" and larger shell are constructed to ASME Boiler and Pressure Vessel Code Section VIII, Div. 1. TXC units are rated for 225 psi tube side and 150 psi shell side working pressures.

ER Units are rated at 300 psi tube side and 200 psi shell side (non-code). Each unit is tested before shipment and ratings are developed through extensive laboratory testing and computer modeling.

Nominal Tonnage Rating Basis

Nominal ratings are based on ARI standard 480, specific conditions being:

1 ton = 12,000 Btu/hr	100° F. liquid entering TXV
54° F. inlet water	7° superheat
44° F. outlet water	35° F R22 Saturated Suction
0.0001 ft ² hr ² F/Btu fouling factor	

Sizing by Nominal Tons

Sizing by nominal tons is done according to ARI standards. Chillers can be selected on a nominal system tons basis, as shown in the catalog, or reflected in the model name. For example, a TXC-50-2 is a nominal 50 ton dual-circuit barrel. This method is reasonably accurate for sizing air-conditioning systems. However, it is not recommended for evaporating temperature below 34° F, or when the fluids used are other than water and R-22. All heat exchangers have capacity limits and careless sizing of chiller barrels leads to needless performance problems. Undersizing can lead to insufficient cooling and inefficient compressor operation. Oversizing can lead to control valve hunting, poor performance, oil logging, and refrigerant slugging. When your application varies from nominal-air conditioning conditions, such as brine, low-temperature and process cooling applications, utilize Standard Refrigeration's CHILLY selection software or evaporator performance tables, which can be obtained at www.stanref.com or from customer service.

Limitations

1. For cooling water applications a minimum evaporating temperature of 32°F. should be maintained in the evaporator to prevent freezing.
2. Maximum water entering temperature of 70°F.
3. Minimum outgoing water temperature of 36°F.
4. Minimum approach 5° (for approaches 6° or less, system should be designed to insure proper oil return).

Note: For brine, low temperature and special design applications, please consult factory.

Note: Do not exceed maximum stated flow rate.

Technical Assistance and Custom Designs

Standard offers custom design services and computer performance projections on all heat exchange products to help you match product and application accurately. You are invited to contact your nearest sales representative or our office headquarters for prompt assistance.

TX

Ultra Compact Serviceable Chiller Barrels



design features & ratings

MODELS	Circuits	Nominal Tons**		Connections				Specifications				Working Pressure (psig)		
		clean	fouled	Ref. In (ids)	Ref. Out (ids)	W Fluid Conn.	T (ft)	Fluid Volume (gal)	Tube Length (inches)	Shell Diameter (inches)	Shipping Weight (lbs)	Shell Side	Tube Side	
1-CIRCUIT														
TX2-1	1	2.8	2.2	5/8	7/8	1 _{FPT}	3/8	0.4	24	2 3/4	46	225	225	
TX3-1	1	3.8	2.9	5/8	7/8	1 _{FPT}	3/8	0.4	24	2 3/4	50	225	225	
TX5-1	1	6.0	4.8	5/8	1 1/8	1 1/4 _{FPT}	1/2	1.6	36	4	62	225	225	
TX6-1	1	8.7	7.1	5/8	1 1/8	1 1/2 _{FPT}	1/2	1.5	36	4	64	225	225	
TX7 1/2-1	1	9.5	7.8	7/8	1 5/8	1 1/2 _{FPT}	1/2	1.4	36	4	66	225	225	
TX10-1	1	11.9	11.0	7/8	1 5/8	2 _{FPT}	1/2	1.2	36	4	70	225	225	
TX12-1	1	15.8	13.0	7/8	1 5/8	2 _{FPT}	1/2	3.4	36	6	120	225	225	
TX15-1	1	20.2	16.5	1 1/8	2 1/8	2 1/2 _{FPT}	1/2	3.2	36	6	128	225	225	
TX20-1	1	23.9	19.7	1 1/8	2 1/8	3 _{FPT}	1/2	2.9	36	6	136	225	225	
TX25-1	1	26.9	22.3	1 1/8	2 5/8	3 _{FPT}	1/2	2.6	36	6	142	225	150	
TXC30-1	1	32.1	30.0	1 1/8	2 5/8	3 _{MPT}	3/4	9.3	72	6 5/8	414	300	150	
TXC40-1	1	42.8	40.0	1 3/8	2 5/8	3 _{MPT}	3/4	17.5	72	8 5/8	563	300	150	
TXC50-1	1	53.7	50.0	1 3/8	3 1/8	4" FLANGE	3/4	17.1	72	8 5/8	594	300	150	
TXC60-1	1	64.3	60.0	1 5/8	3 1/8	4" FLANGE	3/4	19.8	84	8 5/8	642	300	150	
TXC75-1	1	80.7	75.0	2 1/8	3 1/8	5" FLANGE	3/4	19.5	84	8 5/8	671	300	150	
TXC100-1	1	124.7	110.0	2 1/8	3 5/8	5" FLANGE	3/4	28.4	84	10 3/4	1070	225	150	
TXC120-1	1	136.8	120.0	2 1/8	3 5/8	6" FLANGE	3/4	26.9	84	12 3/4	1080	225	150	

2-CIRCUIT

TX10-2	2	11.9	11.0	5/8	1 1/8	2 _{FPT}	1/2	1.2	36	4	70	225	225
TX12-2	2	15.8	13.0	5/8	1 1/8	2 _{FPT}	1/2	3.4	36	6	120	225	225
TX15-2	2	20.2	16.5	7/8	1 5/8	2 1/2 _{FPT}	1/2	3.2	36	6	128	225	225
TX20-2	2	23.9	19.7	7/8	1 5/8	3 _{FPT}	1/2	2.9	36	6	136	225	225
TX25-2	2	26.9	22.3	7/8	1 5/8	3 _{FPT}	1/2	2.6	36	6	142	225	225
TXC30-2	2	32.1	30.0	7/8	1 5/8	3 _{MPT}	3/4	9.3	72	6 5/8	404	300	150
TXC40-2	2	42.8	40.0	1 1/8	2 1/8	3 _{MPT}	3/4	17.5	72	8 5/8	556	300	150
TXC50-2	2	53.7	50.0	1 1/8	2 1/8	4" FLANGE	3/4	17.1	72	8 5/8	581	300	150
TXC60-2	2	64.3	60.0	1 1/8	2 5/8	4" FLANGE	3/4	19.8	84	8 5/8	634	300	150
TXC75-2	2	80.7	75.0	1 3/8	2 5/8	5" FLANGE	3/4	19.5	84	8 5/8	662	300	150
TXC100-2	2	124.7	110.0	1 3/8	3 1/8	5" FLANGE	3/4	28.4	84	10 3/4	1070	225	150
TXC120-2	2	136.8	120.0	1 3/8	3 1/8	6" FLANGE	3/4	26.9	84	12 3/4	1080	225	150
TXC150-2	2	173.0	152.3	1 3/8	2 5/8	6" FLANGE	3/4	34.0	84	14	1600	225	150
TXC175-2	2	198.0	174.5	1 3/8	2 5/8	6" FLANGE	3/4	31.0	84	14	1700	225	150
TXC200-2	2	242.0	212.9	1 3/8	3 1/8	8" FLANGE	3/4	42.0	84	16	2100	225	150
TXC250-2	2	284.0	251.1	1 3/8	3 1/8	8" FLANGE	3/4	39.0	84	16	2200	225	150
TXC275-2	2	309.0	273.5	2 1/8	4 1/8	8" FLANGE	3/4	54.0	84	18	2600	225	150
TXC300-2	2	361.0	319.7	2 1/8	3 5/8	8" FLANGE	3/4	73.0	84	20	2800	225	150
TXC500-2	2	573.0	505.5	2 1/8	4 1/8	10" FLANGE	3/4	101.0	84	24	3600	225	150

MULTI-CIRCUIT

TX15-3	3	22.1	18.1	5/8	1 1/8	2 1/2 _{FPT}	1/2	8.4	72	6	145	225	225
TX20-4	4	26.7	24.6	5/8	1 1/8	3 _{FPT}	1/2	8.1	72	6	155	225	225

**Clean ratings: As tested per ARI standard 480-01

Fouled ratings: Include a additive fouling coefficient of 0.0001 ft² hr² F/Btu over clean rating per ARI standard 480-01

- Serviceable
- 30% - 50% smaller than comparable models
- Easier to handle and position
- New advanced design
- UL listed or ASME
- 3/4" insulation

- Single and dual circuit designs
- 3 and 4 circuit designs available
- 33 TX models from 2 thru 500 tons
- Ideal for OEM replacements
- New TXC designs for 30 thru 75 Tons

MODELS

1-CIRCUIT	Dimensions (Inches)															
	D	H	L	A	B	C	E	F	G	I	J	K	M	N	O	Fig.
TX2-1	4	6 1/16	28 1/4	2 1/8	21 7/8	3 1/2	23 5/8	3/8	2 1/2	2 1/2	3 7/8	3/4	11/16	-	-	A
TX3-1	4	6 1/16	28 1/4	2 1/8	21 7/8	3 1/2	23 5/8	3/8	2 1/2	2 1/2	3 7/8	3/4	11/16	-	-	A
TX5-1	5 1/2	8	40 1/4	2 5/16	33 11/16	3 1/2	35 5/8	3/8	3	3 1/2	5	15/16	3/4	-	-	A
TX6-1	5 1/2	8	40 1/4	2 7/16	33 9/16	3 1/2	35 5/8	3/8	3	3 1/2	5	15/16	3/4	-	-	A
TX7 1/2-1	5 1/2	8	40 1/4	2 7/16	33 9/16	3 1/2	35 5/8	3/8	3	3 1/2	5	1 1/16	15/16	-	-	A
TX10-1	5 1/2	8	40 1/4	2 13/16	33 3/16	3 1/2	35 5/8	3/8	3	3 1/2	5	1 1/16	15/16	-	-	A
TX12-1	7 3/4	10	41 1/4	2 15/16	33 1/16	4 1/2	35 1/2	1/2	3	5 3/4	6	1 3/16	15/16	-	-	A
TX15-1	7 3/4	11	41 1/4	3 3/16	32 13/16	4 1/2	35 1/2	1/2	3	5 3/4	6	1 1/2	1	-	-	A
TX20-1	7 3/4	11	41 1/4	3 1/2	32 1/2	4 1/2	35 1/2	1/2	3	5 3/4	6	1 1/2	1	-	-	A
TX25-1	7 3/4	11	41 1/4	3 1/2	32 1/2	4 1/2	35 1/2	1/2	3	5 3/4	6	1 1/2	1 1/4	-	-	A
TXC30-1	10 3/8	13 1/2	81 3/4	4 1/4	67 3/4	8	54	18	3	5 1/4	-	1 3/4	1 3/4	-	-	B
TXC40-1	11 5/8	15 1/2	81 3/4	4 1/2	67 1/2	8	54	18	3	7 1/8	-	2 1/8	1 2/3	-	-	B
TXC50-1	11 5/8	15 1/2	81 3/4	4 3/4	67 1/4	8	54	18	3	7 1/8	-	2 1/4	2 3/8	-	-	B
TXC60-1	11 5/8	15 1/2	93 3/4	4 3/4	79 1/4	8	63	21	3	7 1/8	-	2 1/4	2 3/8	-	-	B
TXC75-1	11 5/8	15 1/2	93 3/4	5 1/2	78 1/2	8	63	21	3	7 1/8	-	2 1/4	2 3/8	-	-	B
TXC100-1	16 5/8	19 5/8	94 7/8	5 3/4	78 1/4	8 3/8	63	21	5	11 1/4	-	2 4/9	2 3/4	-	-	B
TXC120-1	16 5/8	19 5/8	94 7/8	6 3/8	77 5/8	8 3/8	63	21	5	11 1/4	-	2 4/9	2 3/4	-	-	B

2-CIRCUIT

TX10-2	5 1/2	8	40 1/4	2 13/16	33 3/16	3 1/2	35 5/8	3/8	3	3 1/2	5	11/16	15/16	3/4	1	C
TX12-2	7 3/4	10	41 1/4	2 15/16	33 1/16	4 1/2	35 1/2	1/2	3	5 3/4	6	1	3/4	1 1/8	1 1/8	C
TX15-2	7 3/4	11	41 1/4	3 3/16	32 13/16	4 1/2	35 1/2	1/2	3	5 3/4	6	1 3/16	7/8	1 1/4	1 1/4	C
TX20-2	7 3/4	11	41 1/4	3 1/2	32 1/2	4 1/2	35 1/2	1/2	3	5 3/4	6	1 3/16	7/8	1 1/4	1 1/4	C
TX25-2	7 3/4	11	41 1/4	3 1/2	32 1/2	4 1/2	35 1/2	1/2	3	5 3/4	6	1 3/16	7/8	1 1/4	1 1/4	C
TXC30-2	10 3/8	13 1/2	81 3/4	4 1/4	67 3/4	8	54	18	3	5 1/4	-	1 1/2	1 1/2	1 3/4	1 3/4	D
TXC40-2	11 5/8	15 1/2	81 3/4	4 1/2	67 1/2	8	54	18	3	7 1/8	-	1 3/4	1 5/8	2	2	D
TXC50-2	11 5/8	15 1/2	81 3/4	4 3/4	67 1/4	8	54	18	3	7 1/8	-	1 3/4	1 5/8	2	2	D
TXC60-2	11 5/8	15 1/2	93 3/4	4 3/4	79 1/4	8	63	21	3	7 1/8	-	1 3/4	1 5/8	2	2	D
TXC75-2	11 5/8	15 1/2	93 3/4	5 1/2	78 1/2	8	63	21	3	7 1/8	-	1 3/4	1 5/8	2	2	D
TXC100-2	16 5/8	19 5/8	94 7/8	5 3/4	78 1/4	8 3/8	63	21	3	11 1/4	-	2 3/8	2 2/3	2 1/4	3 1/8	D
TXC120-2	16 5/8	19 5/8	94 7/8	6 3/8	77 5/8	8 3/8	63	21	3	11 1/4	-	2 3/8	2 2/3	2 1/4	3 1/2	D
TXC150-2	18 5/8	20 7/8	96 5/8	6 3/8	77 5/8	9 3/8	63	21	5 1/2	12	-	2 5/8	2 5/8	3	3	D
TXC175-2	18 5/8	20 7/8	96 5/8	6 3/8	77 5/8	9 3/8	63	21	5 1/2	12	-	2 5/8	2 5/8	3	3	D
TXC200-2	21	24 1/8	96 5/8	7 1/2	76 1/2	9 3/8	63	21	5 1/2	12	-	2 5/8	2 5/8	3 1/3	3 1/3	D
TXC250-2	21	24 1/8	96 5/8	7 1/2	76 1/2	9 3/8	63	21	5 1/2	12	-	2 5/8	2 5/8	3 1/3	3 1/3	D
TXC275-2	23	24 7/8	96 7/8	7 1/2	76 1/2	9 3/8	63	21	5 1/2	12	-	3	3	4	4	D
TXC300-2	25	26 7/8	96 7/8	7 1/2	76 1/2	9 3/8	63	21	5 1/2	12	-	3 3/4	3 3/4	4 1/4	4 1/4	D
TXC400-2	25	26 7/8	96 7/8	8 5/8	75 3/8	9 3/8	63	21	5 1/2	12	-	3 3/4	3 3/4	4 1/4	4 1/4	D
TXC500-2	29	31 1/8	97 1/8	8 5/8	75 3/8	9 3/8	63	21	5 1/2	12	-	3 1/2	3 1/2	4 5/8	4 5/8	D

MULTI-CIRCUIT

TX15-3	7 3/4	9 7/8	81	3 13/16	68 13/16	4 1/2	72	1/2	3	5 3/4	6	2 1/8	1 5/8	na	na	E
TX20-4	7 3/4	9 7/8	81	3 3/8	68 5/8	4 1/2	72	1/2	3	5 3/4	6	1 5/8	1	13/16	7/8	F

Figure A
1-Circuit

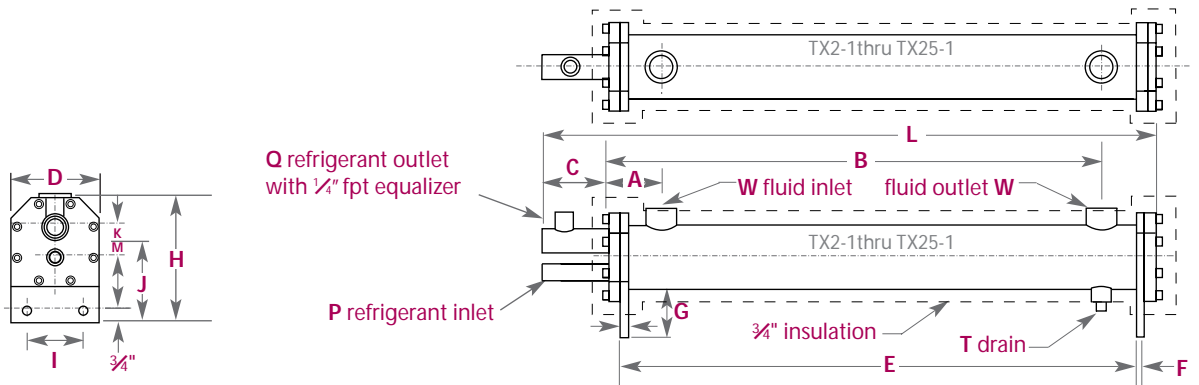

Figure B
1-Circuit

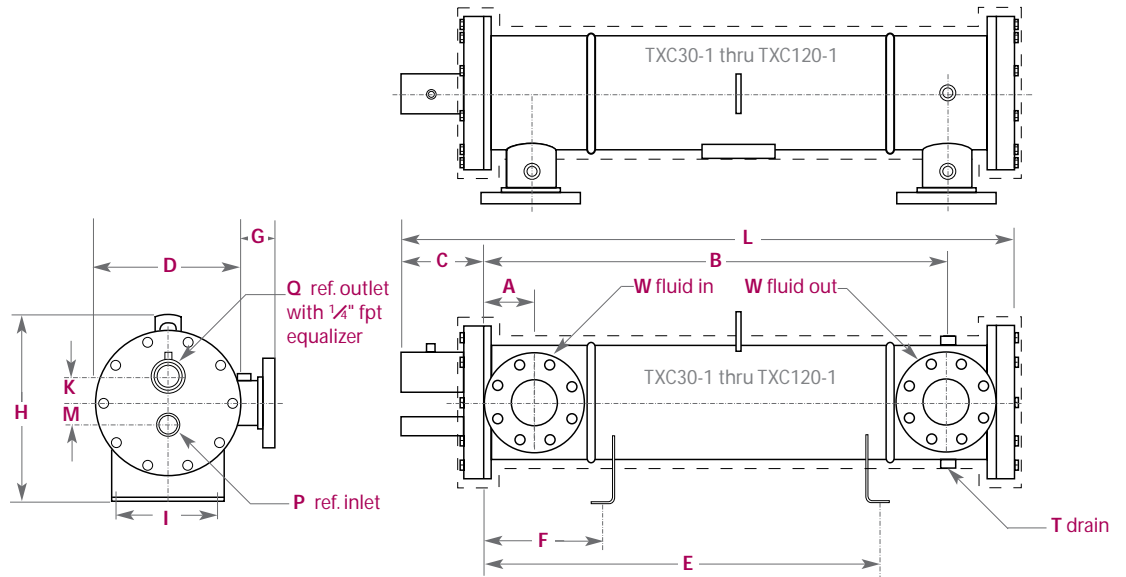
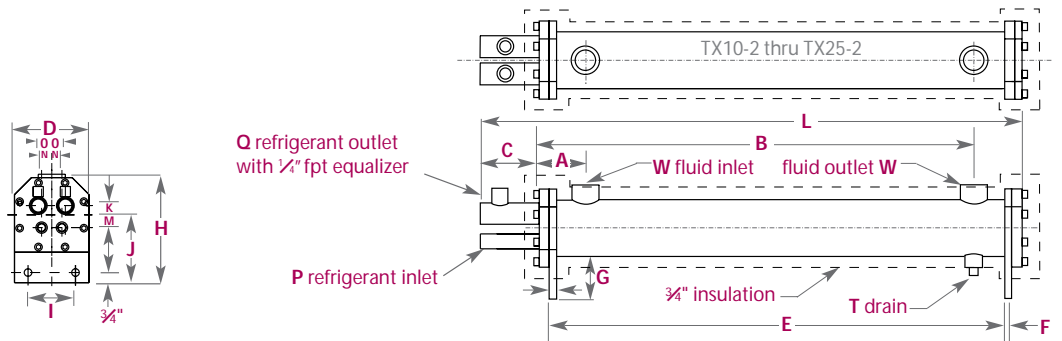

Figure C
2-Circuit



Dimensions shown do not include the 3/8" factory insulation.

Figure D
2-Circuit

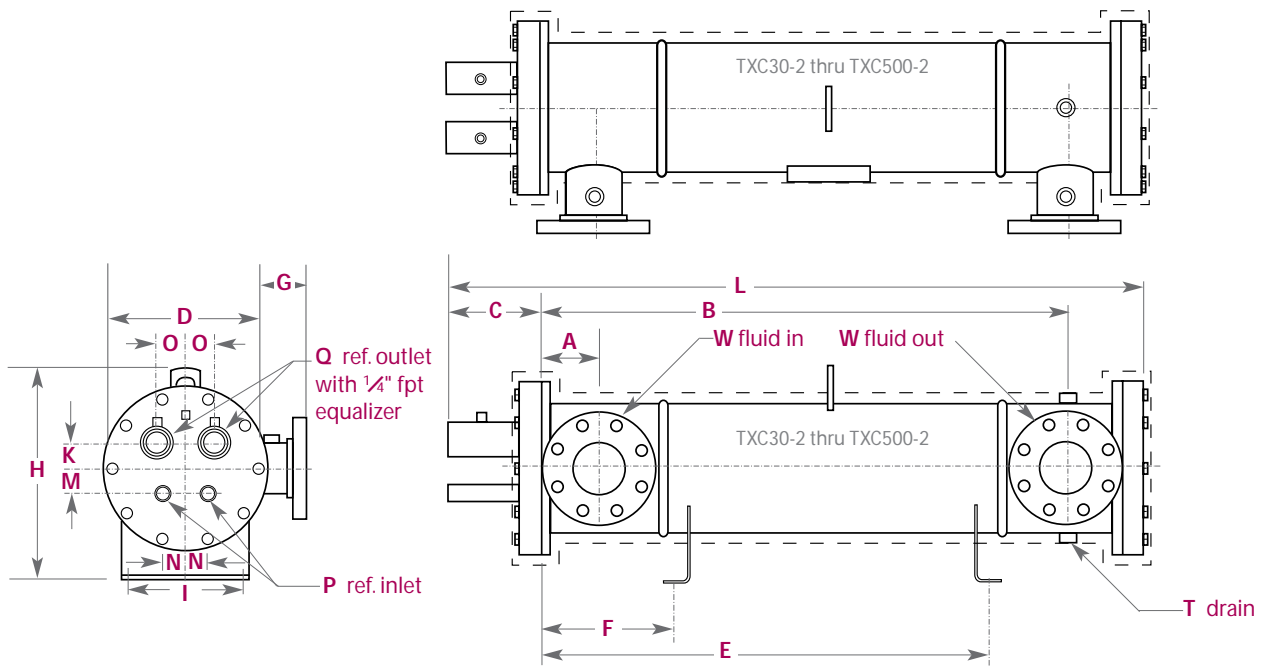

Figure E
3-Circuit

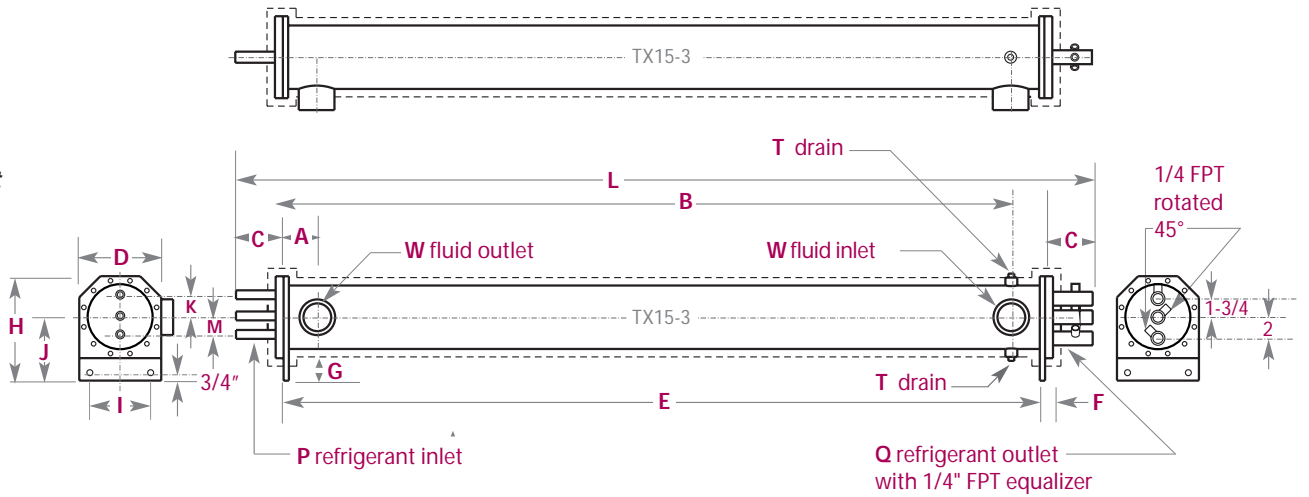
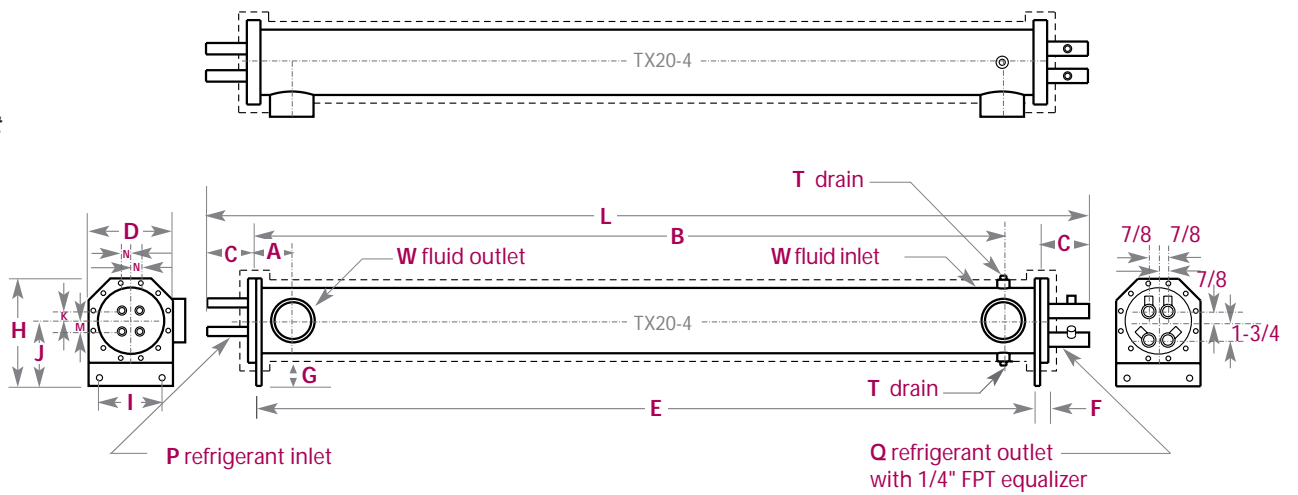

Figure F
4-Circuit



ER

One-Pass or Three-Pass Replacement Evaporators



design features & ratings

Water Flow Rates

There is one baffle configuration per ER model. As a result, the water flow rate at the job site will need to be adjusted to obtain the design water flow rate. At a range of 10°F, the water flow rate should be 2.4 gpm/ton.

Construction Materials

ER evaporator shells are constructed with ASME grade carbon steel. Enhanced copper tubing is mechanically expanded for a superior seal into machined carbon steel tubesheets. Tubing wall thickness is 0.018". Removable endplates, refrigerant and water connections are constructed from carbon steel. All baffles are made from corrosion resistant materials.

Refrigerant Connections

The refrigerant side configuration for the ER evaporators is 3-Pass with nozzles at opposite ends. As a result, the refrigerant nozzles are on the same ends, but may not be in the same locations as the other OEM Single Pass evaporators.

MODELS 1-Circuit	Nom. Cap. Tons.	Pressure Drop (psi)						Water In & Out (mpt)	Refrig. Inlet (ids)	Refrig. Outlet (ids)	Working Pressure (psi)	
			A	B	D	E	K				Shell Side	Tube Side
ERS00336	4.0	2.1	4	49.13	34.63	10.50	8.50	1 1/8*	5/8	1 1/8	225	225
ERS00436	7.1	2.4	4	49.13	34.13	10.88	8.88	1 3/8*	7/8	1 3/8	225	225
ERS00448	9.7	4.6	4	61.13	46.13	10.88	8.88	1 3/8*	7/8	1 3/8	225	225
ERS00536	9.8	2.7	6	49.13	33.63	12.06	9.06	1 5/8*	7/8	2 1/8	225	225
ERS00560	18.2	3.8	6 5/8	73.13	57.63	12.69	9.38	1 5/8*	7/8	2 1/8	200	300
ERS00636	16.0	5.1	6 5/8	45.63	32.00	11.38	8.06	3	1 1/8	2 1/8	200	300
ERS00648	21.4	2.7	6 5/8	57.63	44.00	11.38	8.06	3	1 1/8	2 1/8	200	300
ERS00660	27.7	4.8	8 5/8	69.63	56.00	11.38	8.06	3	1 1/8	2 1/8	200	300
ERS00736	27.5	4.3	8 5/8	47.13	32.13	14.06	10.13	3	1 1/8	2 5/8	200	300
ERS00748	34.6	3.7	8 5/8	59.13	44.13	14.06	10.13	3	1 1/8	2 5/8	200	300
ERS00760	40.9	3.8	8 5/8	71.13	56.13	14.06	10.13	3	1 1/8	2 5/8	200	300
ERS00848	44.9	5.9	10 3/4	59.88	41.50	15.19	10.69	3	1 1/8	2 5/8	200	300
ERS00860	53.9	4.2	10 3/4	71.88	53.50	15.19	10.69	3	1 1/8	2 5/8	200	300
ERS01048	54.2	3.6	10 3/4	60.50	41.50	16.56	11.50	4	1 3/8	3 1/8	200	300
ERS01060	68.4	4.5	10 3/4	72.50	53.50	16.56	11.50	4	1 3/8	3 1/8	200	300
ERS01160	84.6	4.9	12 3/4	73.00	53.50	17.69	12.06	4	1 3/8	3 1/8	200	300
ERS01260	93.3	6.0	12 3/4	73.63	53.50	18.94	12.75	4	1 5/8	3 1/8	200	300
ERS01360	111.4	5.9	14	74.25	53.50	20.06	13.31	4	1 5/8	3 1/8	200	300

*ids

2-Circuit

ERD00636	16.0	5.1	6 5/8	47.50	32.00	11.38	8.06	3	7/8	1 5/8	200	300
ERD00648	21.4	2.7	6 5/8	59.50	44.00	11.38	8.06	3	7/8	1 5/8	200	300
ERD00660	27.7	4.8	8 5/8	71.50	56.00	11.38	8.06	3	7/8	1 5/8	200	300
ERD00736	27.5	4.3	8 5/8	50.50	32.13	14.06	10.13	3	7/8	1 5/8	200	300
ERD00748	34.6	3.7	8 5/8	62.50	44.13	14.06	10.13	3	7/8	1 5/8	200	300
ERD00760	40.9	3.8	8 5/8	74.50	56.13	14.06	10.13	3	7/8	1 5/8	200	300
ERD00848	44.9	5.9	10 3/4	63.13	41.50	15.19	10.69	3	1 1/8	2 1/8	200	300
ERD00860	53.9	4.2	10 3/4	75.13	53.50	15.19	10.69	3	1 1/8	2 1/8	200	300
ERD01048	54.2	3.6	10 3/4	65.13	41.50	16.56	11.50	4	1 1/8	2 1/8	200	300
ERD01060	68.4	4.5	10 3/4	77.13	53.50	16.56	11.50	4	1 1/8	2 1/8	200	300
ERD01160	84.6	4.9	12 3/4	77.63	53.50	17.69	12.06	4	1 3/8	2 5/8	200	300
ERD01260	93.3	6.0	12 3/4	78.25	53.50	18.94	12.75	4	1 3/8	2 5/8	200	300
ERD01360	111.4	5.9	14	78.88	53.50	20.06	13.31	4	1 5/8	3 1/8	200	300

ERS
1-Circuit

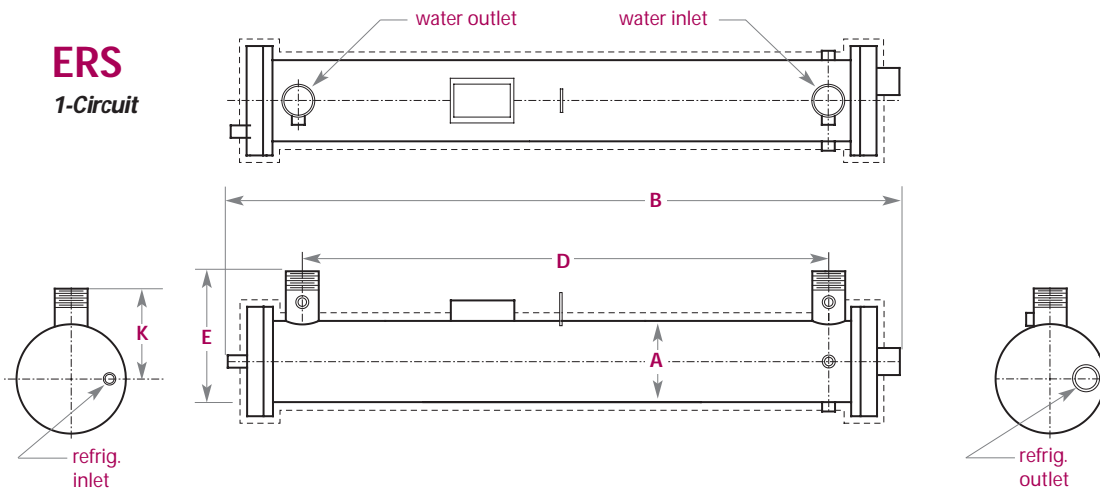

ERD
2-Circuit

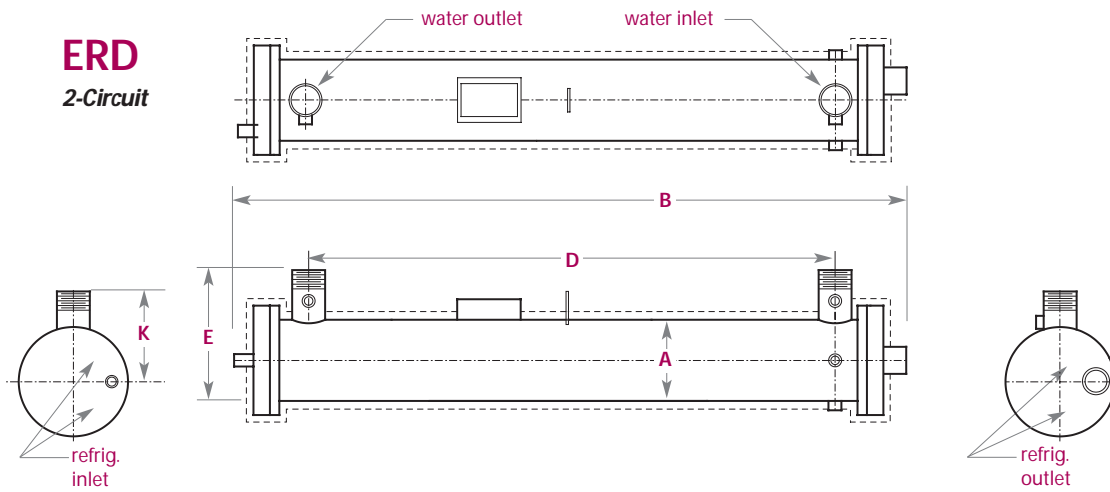

ICE RINK CHILLER BARRELS



Standard Refrigeration can design special chiller barrels for Ice Rink applications special for your needs. Designs are available with enhanced copper tubing for ethelene glycol solutions or special cupronickel tubing for calcium chloride brines which are commonly used in Ice Rink systems

Our models are designed to boost efficiency, reduce corrosion and increase the life of your chiller. Special baffle designs are incorporated to reduce the pressure drops associated with the high flow conditions found in Ice Rinks and similar applications.

All chiller come with standard features like insulation, lifting lugs and feet for easy mounting. Standard's ice rink chillers are available in single and dual circuit designs and can be customized to meet your physical and performance requirements.

Call the factory or your local sales representative for sizing and selection information.

CHILLER BARREL



gasket cross reference

MODELS	Front (GASKE-)	Rear (GASKE-)	Single Circuit	Dual Circuit	Quad Circuit
TX 2	2865	2865	Fig. A	NA	NA
TX 3	2865	2865	Fig. A	NA	NA
TX 5	2872	2872	Fig. A	NA	NA
TX 6	2872	2872	Fig. A	NA	NA
TX 7.5	2872	2872	Fig. A	NA	NA
TX 10	2872	2872	Fig. A	Fig. C	NA
TX 12	2889	2889	Fig. A	Fig. C	NA
TX 15	2889	2889	Fig. A	Fig. C	NA
TX 20	2889	2889	Fig. A	Fig. C	NA
TX 25	2889	2889	Fig. A	Fig. C	NA
TXC 30	2218	2218	Fig. B	Fig. D	NA
TXC 40	2227	2227	Fig. B	Fig. D	NA
TXC 50	2227	2227	Fig. B	Fig. D	NA
TXC 60	2227	2227	Fig. B	Fig. D	NA
TXC 75	2227	2227	Fig. B	Fig. D	NA
TXC 100	4892	4804	Fig. A	Fig. C	NA
TXC 120	4892	4804	Fig. A	Fig. C	NA
TXC150	3549	3549	NA	Fig. C	NA
TXC175	3549	3549	NA	Fig. C	NA
TXC200	5169	5169	NA	Fig. D	NA
TXC250	5169	5169	NA	Fig. D	NA
TXC275	3675	3675	NA	Fig. C	NA
TXC300	3637	3637	NA	Fig. C	NA
TXC400	3637	4878	NA	Fig. C	NA
TXC500	3532	3532	NA	Fig. D	NA
FSX 5	2522	2553	Fig. A	NA	NA
FSX 10	2218	2218	Fig. A	Fig. C	NA
FSX 15	2218	2218	Fig. A	Fig. C	NA
FSX 20	2227	2227	Fig. B	Fig. D	NA
FSX 25	2227	2227	Fig. B	Fig. D	NA
FSX 30	2227	2227	Fig. B	Fig. D	NA
FSX 40	2236	2236	Fig. B	Fig. D	NA
FSX 50	2236	2236	Fig. B	Fig. D	NA
FSX 60	2245	2245	Fig. B	Fig. D	NA
FSX 75	2245	2245	Fig. B	Fig. D	NA
FSX 100	2245	2245	Fig. A	Fig. C	NA
FSX 120	2254	2254	Fig. A	Fig. C	NA
FSX 150	2263	2263	Fig. A	Fig. C	NA
FSX 200	1679	1679	Fig. A	Fig. C	NA

Figure A
Single Circuit
Dual Pass

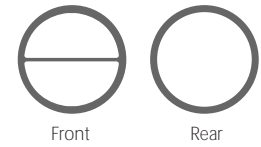

Figure B
Single Circuit
Four Pass

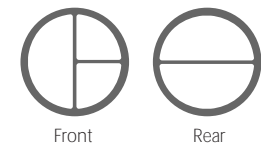

Figure C
Dual Circuit
Dual Pass

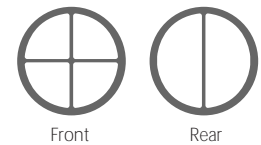

Figure D
Dual Circuit
Four Pass

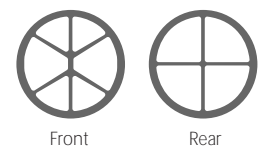
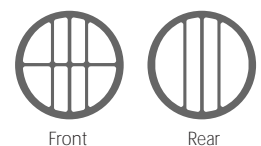

Figure E
Quad Circuit
Dual Pass



SCT



Vertical Subcooler

design features & ratings

- Vertical installation for smaller footprint
- Welded and sealed construction
- Conforms to ASME or UL requirements
- 3/4" insulation
- Rugged shell and coil design
- 6 SCT models from 2 thru 18 tons
- Increase BTU Loading
- Decrease Electrical Usage

MODELS	Nom'l Tons*	Dimensions				Connections†					Shipping Weight (lbs)
		D	H	A	B	P (ids)	Q (ids)	R (ids)	S (ids)	C (fpt)	
SCT2	2	6 5/8	23 7/8	1 3/4	14 3/8	5/8	1 3/8	7/8	7/8	3/8	63
SCT4	3.9	8 5/8	25	2 1/4	15 3/8	5/8	1 3/8	1 1/8	1 1/8	3/8	73
SCT6	5.9	8 5/8	29 1/2	1 7/8	19 7/8	5/8	1 3/8	1 3/8	1 3/8	3/8	108
SCT9	8.9	10 3/4	31 1/2	2 9/16	21 3/16	7/8	1 5/8	2 1/8	2 1/8	1/2	148
SCT12A	11.8	12 3/4	40 1/4	3 1/2	30	1 1/8	2 1/8	2 1/8	2 1/8	1/2	240
SCT18A	17.7	12 3/4	50 1/4	3 1/2	40	1 1/8	2 1/8	2 5/8	2 5/8	1/2	280

* based on R-22 liquid inlet at 100°F. and 50°F. outlet temperature with R-22 evaporating at 40°F.

† Refrigerant fittings 1 3/4" length

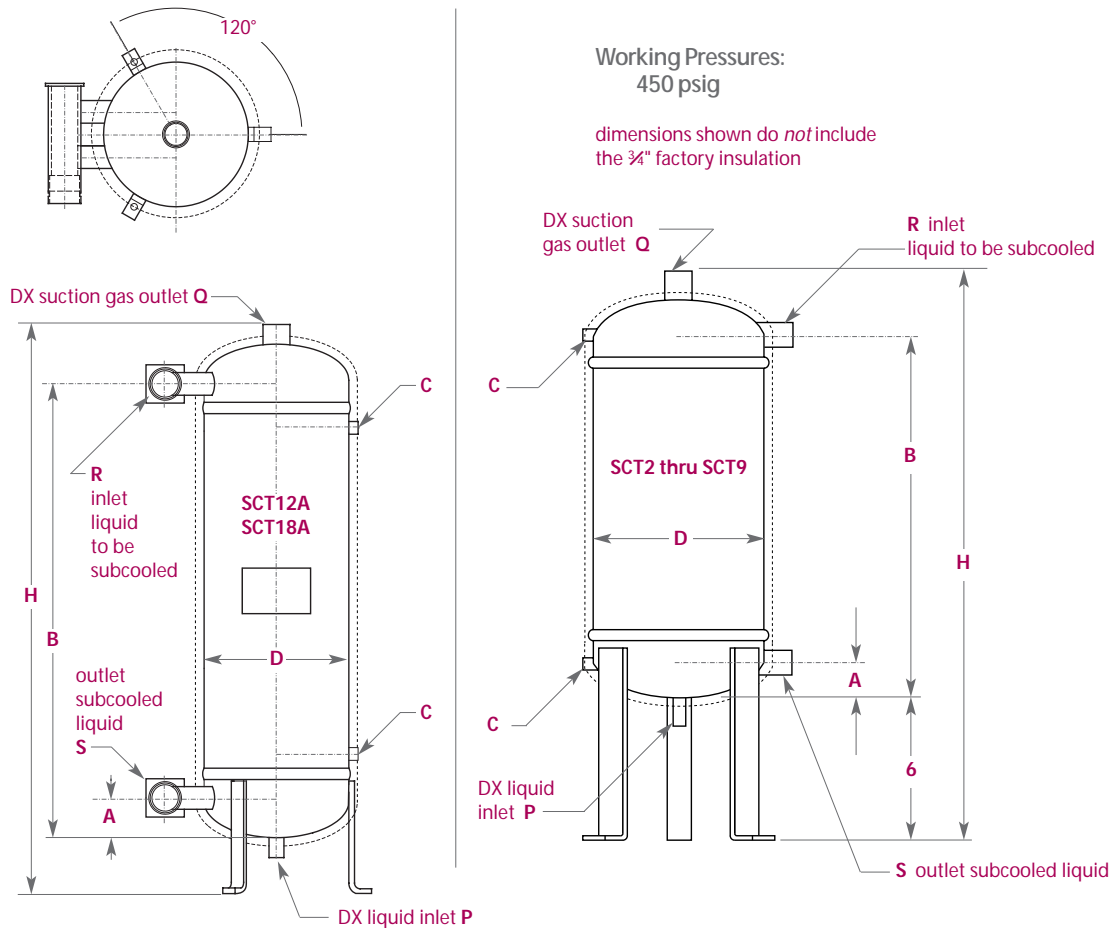

CBKIT

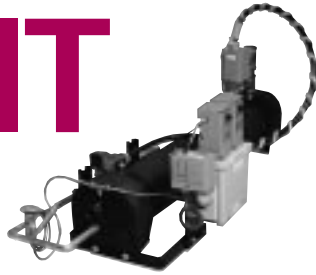

Low-Side ChillerBuilder Kits

Kits Now Available up to 75 Tons

design features & ratings

- Uses super compact TX chiller barrel
- Brand name components
- One, two, three and four circuit options
- NEW three and four circuit models available, ideal for achieving up to 20 tons with single phase compressors
- Available in ranges from two to 75 tons
- Entire kit can be assembled in less than one hour
- Chiller barrel included

- Included components**
- Framework
 - Temperature controls
 - Low pressure switch
 - Expansion valve
 - Solenoids
 - Control power supplies
 - Freezestat
 - Flow switch
 - Sight glasses
 - Custom piping

KIT 1-CIRCUIT	ChillerBuilder Kit Dimensions										W	P	Q
	Nominal Tons*	Circuits	TX Model	TX-Kit	A	B	C	D	H	L	Water Conn.	Liquid Conn.	Suction Conn.
CBKIT2-1	2	1	TX2-1	TXKIT1	21	18 1/4	19 3/4	14	14	30 1/4	1	5/8	7/8
CBKIT3-1	3	1	TX 3-1	TXKIT2	26	18 1/4	19 3/4	18	14	30 1/4	1	5/8	7/8
CBKIT5-1	5	1	TX 5-1	TXKIT2	26	18 1/4	31 3/8	18	16	42 1/4	1 1/4	5/8	1 1/8
CBKIT6-1	6	1	TX 6-1	TXKIT3	27	18 1/4	31 1/8	18	19	42 1/4	1 1/2	5/8	1 1/8
CBKIT7.5-1	7 1/2	1	TX 7 1/2-1	TXKIT3	27	18 1/4	31 1/8	18	19	42 1/4	1 1/2	5/8	1 5/8
CBKIT10-1	10	1	TX10-1	TXKIT3	27	18 1/4	30 3/8	18	19	42 1/4	2	5/8	1 5/8 ₁
CBKIT12-1	12	1	TX12-1	TXKIT3	27	19 3/8	30 1/8	18	21	43 1/4	2	5/8	1 5/8
CBKIT15-1**	15	1	TX15-1	TXKIT4	32	20 3/8	29 5/8	18	21	44 1/4	2 1/2	7/8	2 1/8
CBKIT20-1**	20	1	TX20-1	TXKIT4	32	20 3/8	29	18	21	44 1/4	3	7/8	2 1/8
CBKIT25-1**	25	1	TX25-1	TXKIT4	32	20 3/8	29	18	21	44 1/4	3	7/8	2 5/8
CBKIT30-1‡	30	1	TXC30-1	TXCKIT5							3	1 1/8	2 5/8
CBKIT40-1‡	40	1	TXC40-1	TXCKIT6							3	1 3/8	2 5/8

2-CIRCUIT

CBKIT10-2	10	2	TX10-2	DTXKIT 10-12	29	18 1/4	30 3/8	20	17	45 1/4	2	5/8	1 5/8
CBKIT12-2	12	2	TX12-2	DTXKIT 10-12	29	19 3/8	30 1/8	20	19	46 1/4	2	5/8	1 5/8
CBKIT15-2	15	2	TX15-2	DTXKIT 15-20	29	19 3/8	29 5/8	20	21	46 1/4	2 1/2	5/8	2 1/8
CBKIT20-2	20	2	TX20-2	DTXKIT 15-20	29	19 3/8	29	20	21	46 1/4	3	5/8	2 1/8
CBKIT25-2	25	2	TX25-2	DTXKIT 15-20	29	19 3/8	29	20	21	46 1/4	3	5/8	2 5/8
CBKIT30-2‡	30	2	TXC30-2	DTXCKIT 30							3	7/8	1 5/8
CBKIT40-2‡	40	2	TXC40-2	DTXCKIT 40							3	1 1/8	1 5/8
CBKIT50-2‡	50	2	TXC50-2	DTXCKIT 50							4	1 1/8	2 1/8
CBKIT60-2‡	60	2	TXC60-2	DTXCKIT 60							4	1 1/8	2 1/8
CBKIT75-2‡	75	2	TXC75-2	DTXCKIT 75							5	1 3/8	2 5/8

MULTI CIRCUIT

CBKIT15-3	15	3	TX15-3	TXKIT15-3	30 3/4					23 1/4	80	2 1/2	3/8	1 1/8
CBKIT20-4	20	4	TX20-4	TXKIT20-4	30 3/4					23 1/4	182 3/4	3	3/8	1 1/8

120 volts required to operate CBKits.

* Tonnage capacities based on TXV capacities at 35 F suction, 115 F condensing temperature, 54 F inlet water, and 44 F outlet water using R-22

** Pumpdown cycle included with CBKIT15-1, CBKIT20-1, and CBKIT25-1

‡ Kits 30 through 75 tons include unloading feature. Kits with no unloading feature are also available.

All CBKits include chiller barrel. ChillerBuilder kits without chiller barrel are available. Call the factory for more information.

1-Circuit

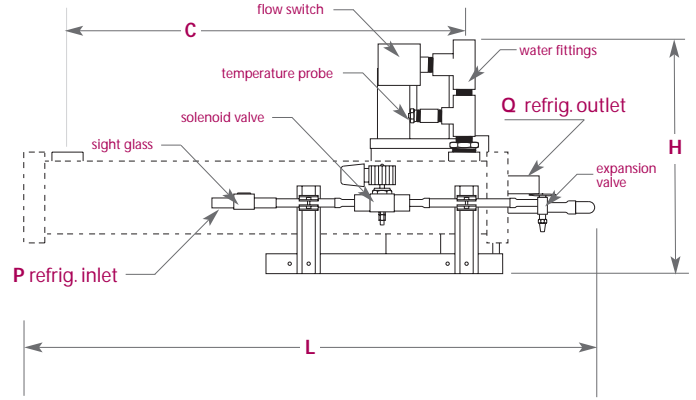
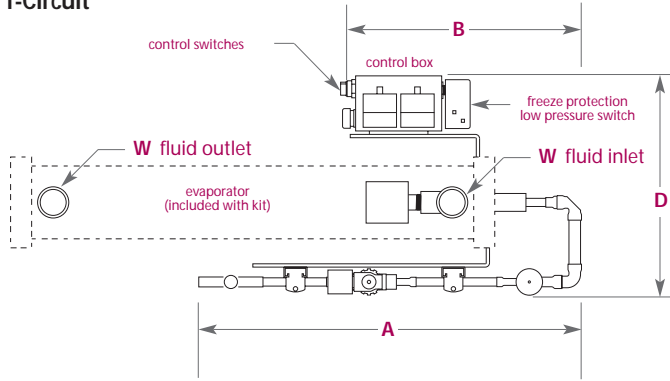

2-Circuit

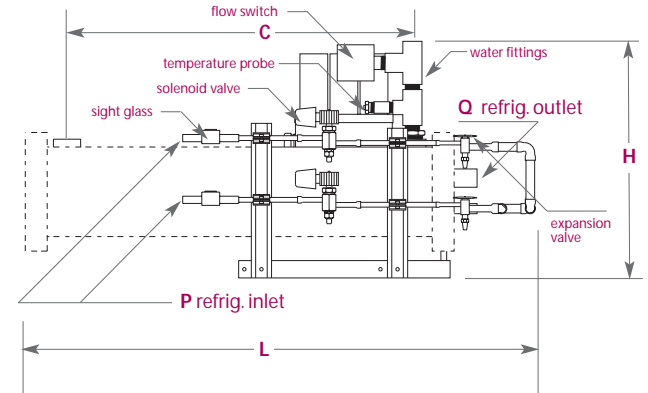
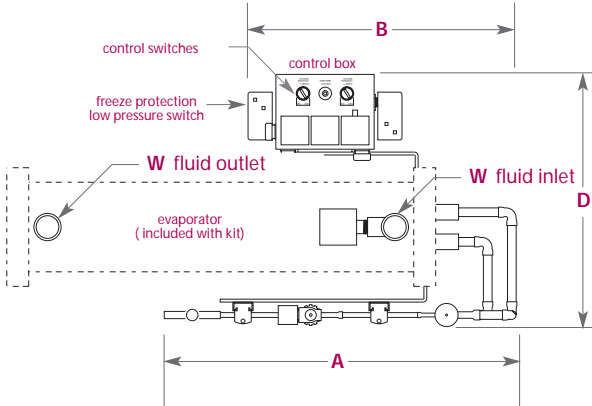

3 & 4 Circuit

Note:
Connection locations vary between 3 & 4 circuit models

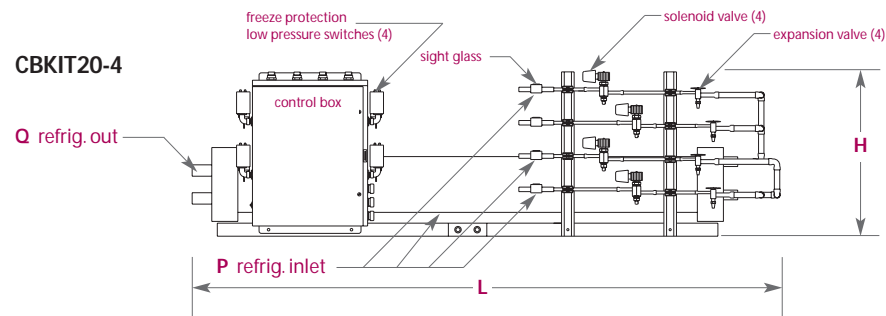
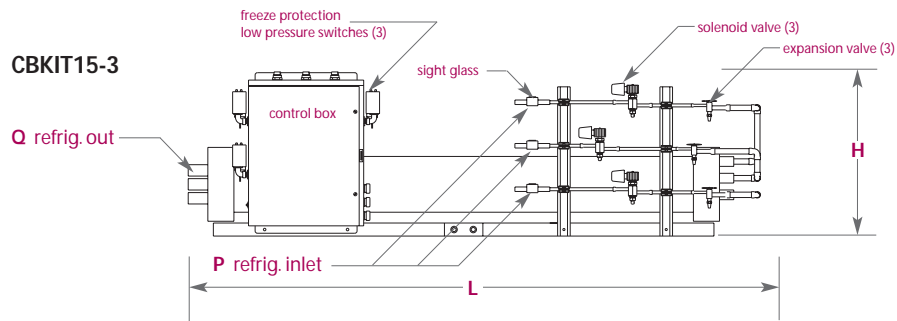
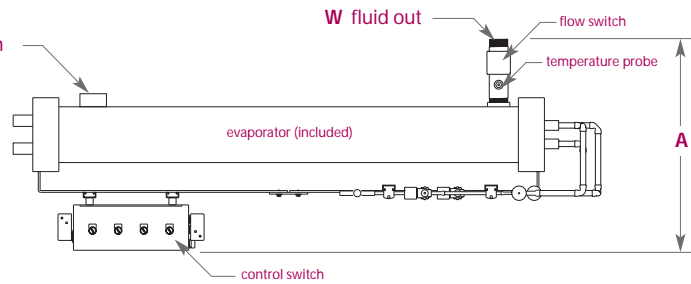

Liquid Receivers

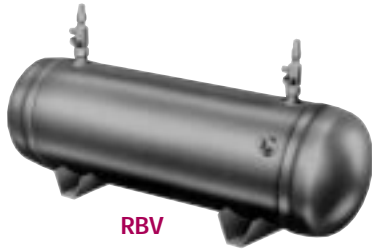

RBV



UV



L

design features & ratings

Conformance

Each Standard stock receiver conforms to UL, CSA or ASME requirements for 450 psi maximum working pressure. Models with an internal diameter under six inches are UL listed; all larger models are made according to ASME code and tagged appropriately.

Pumpdown & Refrigerant Charge

All pumpdowns are calculated at 80% capacity of liquid. Approximately 10% of pumpdown capacity is required to operate receiver properly.

Custom and Ammonia Construction

Custom receivers for halocarbons and ammonia can be built based on application and construction criteria. Receivers may be ordered with or without extra features such as mounting brackets, fusible plugs, special fittings, liquid level indicators and alarm switches, to assure reliable service on virtually any application involving halocarbon type refrigerants.

Selection

Pumpdown Calculation Procedure

Refer to table for calculating pumpdown capacity of any Standard receiver design with elliptical ends. Pumpdown figures shown have been compensated to directly give capacity on 80% of the receiver volume filled with liquid at 90°F.

To figure pumpdown capacity, locate the receiver OD in the first column and read across to find the values for length correction and pounds of pumpdown for refrigerant used. Substitute those values in this formula:

$$\text{Pumpdown} = (\text{overall length} - \text{length correction}) \times (\text{pumpdown per inch})$$

To calculate overall length required for the given OD and specified pumpdown capacity, follow the same procedure given above, using this formula:

$$\text{Overall length} = (\text{pumpdown required} \div \text{pumpdown per inch}) + (\text{length correction})$$

Pumpdown Capacity Table

Receiver OD (inches)	Length Correction (inches)	Pumpdown Capacity pounds per inch effective length			End to Weld (inches)
		R-22	R-134A	R404A	
4	0.9	0.38	0.38	0.33	1 7/8
5	1.1	0.60	0.61	0.52	1 7/8
6	1.2	0.88	0.89	0.76	2 3/8
6 5/8	1.4	1.06	1.08	0.92	2 7/8
7 5/8	1.6	1.42	1.44	1.24	3 3/8
8 5/8	1.8	1.82	1.84	1.58	3 1/8
9 3/4	2.1	2.36	2.39	2.05	3 1/2
10 3/4	2.3	2.80	2.84	2.44	4 1/2
12 3/4	2.6	3.96	4.01	3.45	5 1/2
14	2.9	4.77	4.83	4.15	5 7/8
16	3.2	6.31	6.38	5.49	6 3/8
18	3.7	7.94	8.03	6.90	6 3/4
20	4.0	9.89	10.01	8.60	7 1/4
24	4.9	14.11	14.28	12.28	8 1/2
30	5.2	22.44	22.71	19.52	10
36	5.6	32.68	33.07	28.43	11 1/2

design features & ratings

MODELS	Pumpdown* (lbs)		Dimensions (inches)				Connections (inches)			Shipping Weight (lbs)
	R-22	R-134A	D	L	A	B	P (ids)	Q (ids)	S (fpt)	
285	16	16	5	28	3	25	5/8	5/8	3/8	19
306	25	26	6	30	3 5/8	26 3/8	5/8	5/8	3/8	24
366	31	31	6	36	3 5/8	32 3/8	5/8	5/8	3/8	31
3865	39	40	6 5/8	38	4 3/8	33 5/8	7/8	5/8	1/2	42
2885	48	48	8 5/8	28	4 5/8	23 3/8	1 1/8	7/8	1/2	45
3685	62	63	8 5/8	36	4 5/8	31 3/8	1 1/8	7/8	1/2	65
4285	73	74	8 5/8	42	4 5/8	37 3/8	1 1/8	7/8	1/2	71
4885	84	85	8 5/8	48	4 5/8	43 3/8	1 1/8	1 1/8	1/2	77
6085	106	107	8 5/8	60	4 5/8	55 3/8	1 1/8	1 1/8	1/2	108
36105	94	96	10 3/4	36	6 1/2	29 1/2	1 3/8	1 3/8	1/2	115
48105	128	130	10 3/4	48	6 1/2	41 1/2	1 3/8	1 3/8	1/2	138
60105	162	164	10 3/4	60	6 1/2	53 1/2	1 3/8	1 3/8	1/2	166
72105	195	198	10 3/4	72	6 1/2	65 1/2	1 3/8	1 3/8	1/2	196
96105	262	266	10 3/4	96	6 1/2	89 1/2	1 5/8	1 3/8	1/2	285
48122	180	182	12 3/4	48	8	40	1 5/8	1 3/8	1/2	182
60122	227	230	12 3/4	60	8	52	1 5/8	1 3/8	1/2	218
72122	275	278	12 3/4	72	8	64	2 1/8	1 3/8	1/2	260
96122	370	375	12 3/4	96	8	88	2 1/8	1 3/8	1/2†	360
72145	330	334	14	72	8 3/8	63 5/8	2 1/8	1 5/8	1/2†	316
96145	444	450	14	96	8 3/8	87 5/8	2 5/8	2 1/8	1/2†	425
60166	358	362	16	60	8 7/8	51 1/8	2 5/8	2 1/8	1/2†	306
72166	434	439	16	72	8 7/8	63 1/8	2 5/8	2 1/8	1/2†	380
96166	586	592	16	96	8 7/8	87 1/8	2 5/8	2 1/8	1/2†	486
72188	542	548	18	72	9 7/8	62 1/8	3 1/8	2 1/8	1/2†	510
72201	673	681	20	72	10 1/2	61 1/2	3 1/8	2 5/8	1/2†	570
84201	791	801	20	84	10 1/2	73 1/2	3 1/8	2 5/8	1/2†	639
96201	910	921	20	96	10 1/2	85 1/2	3 1/8	2 5/8	1/2†	756
96241	1,285	1,301	24	96	12 1/2	83 1/2	3 5/8	3 1/8	3/4†	1000
12241	1,624	1,644	24	120	13	107	4 1/8	3 5/8	3/4†	1250
12301	2,576	2,607	30	120	15	105	4 1/8	3 5/8	3/4†	1800

* All pumpdowns are calculated at 80% of receiver volume

Use the following multipliers for refrigerants other than shown above:

† Safety fitting located 30° above centerline below refrigerant outlet

R-12 = R-22 capacity × 1.10

R-502 = R-22 capacity × 1.01

R-404A = R-22 capacity × 0.89

R-507 = R-22 capacity × 0.88

Working Pressure: 450 psi

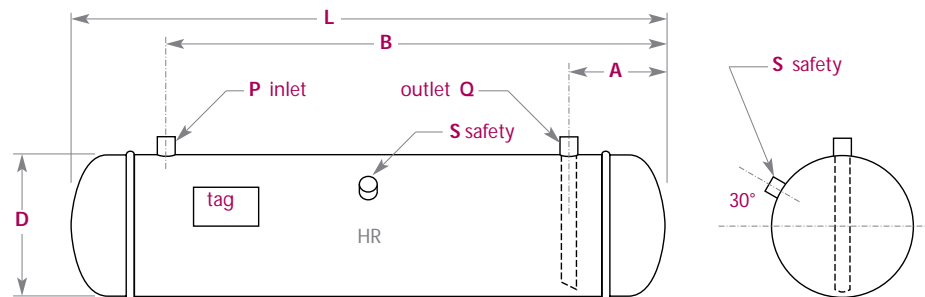

Tag location may vary per model.

MODELS	Pumpdown* (lbs)		Dimensions (inches)						Connections		Valve Part Number	Ship Wt (lbs)
	R-22	R-134A	D	L	A	B	E	F	P & Q (ids)	S (fpt)		
RBV-285	16	16	5	28	3	25	7	21	1/2	3/8	V04ST	24
RBV-366	31	31	6	36	3 5/8	32 3/8	9	27	1/2	3/8	V04ST	35
RBV-3865	39	40	6 5/8	38	4 5/8	33 5/8	9 1/2	28 1/2	5/8	1/2	V05ST	45
RBV-3685	62	63	8 5/8	36	4 5/8	31 3/8	9	27	7/8	1/2	V07ST	69
RBV-4285	73	74	8 5/8	42	4 5/8	37 3/8	10 1/2	31 1/2	1 1/8	1/2	V09ST	75
RBV-36105	94	96	10 3/4	36	6 1/2	29 1/2	9	27	1 1/8	1/2	V09ST	117
RBV-48105	128	130	10 3/4	48	6 1/2	41 1/2	12	36	1 1/8	1/2	V09ST	145
RBV-60105	162	164	10 3/4	60	6 1/2	53 1/2	15	45	1 1/8	1/2	V09ST	170
RBV-48122	180	182	12 3/4	48	8	40	12	36	1 3/8	1/2	V11ST	186
RBV-60122	227	230	12 3/4	60	8	52	15	45	1 3/8	1/2	V11ST	224
RBV-72145	330	334	14	72	8 3/8	63 5/8	18	54	1 5/8	1/2†	valve-85A	339
RBV-96145	444	450	14	96	8 3/8	87 5/8	24	72	1 5/8	1/2†	valve-85A	448
RBV-96166	586	592	16	96	8 7/8	87 1/8	24	72	2 1/8	1/2†	valve-621A	510

* All pumpdowns are calculated at 80% of receiver volume

Use the following multipliers for refrigerants other than shown above:

R-12 = R-22 capacity × 1.10

R-502 = R-22 capacity × 1.01

R-404A = R-22 capacity × 0.89

R-507 = R-22 capacity × 0.88

† Safety fitting located 30° above centerline below refrigerant outlet

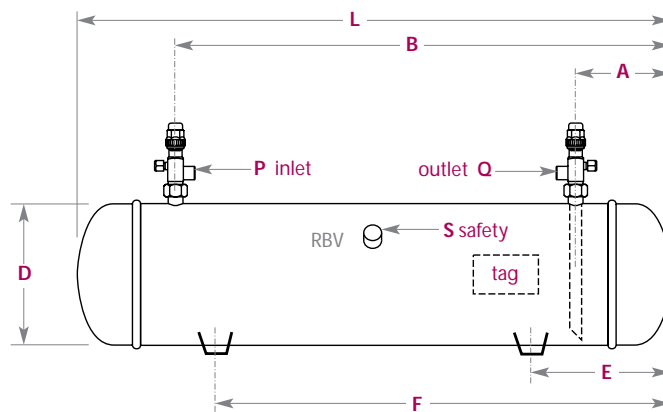

Tag location may vary per model.

Working Pressure: 450 psi

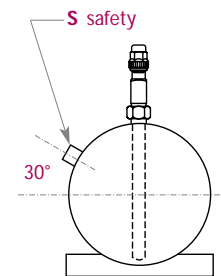

design features & ratings

MODELS	Pumpdown* (lbs)		Dimensions (inches)				Connections			Ship Weight (lbs)
	R-22	R-134A	D	H	A	B	P (ids)	Q (ids)	S (fpt)	
UR-20	18	19	8 5/8	12	5	7	5/8	5/8	3/8	29
UR-28	26	26	8 5/8	16	5	11	5/8	5/8	3/8	35
UR-48	44	45	10 3/4	18	6	11 1/2	1 1/8	7/8	1/2	60
UR-66	61	62	12 3/4	18	6 5/8	11 3/8	1 1/8	1 1/8	1/2	80
UR-72	67	68	12 3/4	20	6 5/8	13 3/8	1 1/8	1 1/8	1/2	88
UR-84	85	85	12 3/4	24	6 5/8	17 3/8	1 1/8	1 1/8	1/2	98
UR-108	101	102	14	24	7 1/2	16 1/2	1 3/8	1 3/8	1/2	111
UR-137	131	133	16	24	8	16	1 3/8	1 3/8	1/2	140
UR-151	156	158	12 3/4	42	6 7/8	34 1/2	1 3/8	1 3/8	1/2	170
UR-174	161	163	18	24	8 3/4	12 1/4	1 5/8	1 5/8	1/2	175
UR-201	206	208	14	46	7 5/8	37 1/2	1 5/8	1 5/8	1/2	210
UR-276	283	286	16	48	8 1/8	39	2 1/8	1 5/8	1/2	245
UR-351	358	362	16	60	8 3/8	51	2 5/8	2 1/8	1/2	300
UR-451	463	468	18	62	9	52 1/2	2 5/8	2 1/8	1/2	435

* All pumpdowns are calculated at 80% of receiver volume

Use the following multipliers for refrigerants other than shown above:

R-12 = R-22 capacity × 1.10

R-502 = R-22 capacity × 1.01

R-404A = R-22 capacity × 0.89

R-507 = R-22 capacity × 0.88

Working Pressure: 450 psi

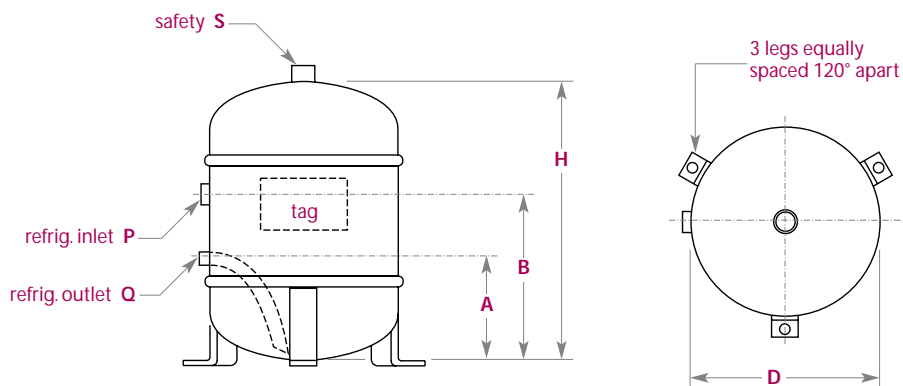

Tag location may vary per model.

design features & ratings

MODELS	Pumpdown* (lbs)		Dimensions (inches)				Connections		Valve Part Number	Ship Weight (lbs)
	R-22	R-134A	D	H	A	B	P & Q (ids)	S (fpt)		
UV-30	29	30	8 5/8	18	5 1/8	12 7/8	1/2	3/8	H04ST	40
UV-40	40	41	8 5/8	24	5 1/8	19 3/8	5/8	3/8	H05ST	47
UV-50	55	56	8 5/8	32	5 1/4	26 3/4	7/8	3/8	H07ST	60
UV-70	72	73	10 3/4	28	6	21 1/2	1 1/8	1/2	H09ST	90
UV-100	100	101	10 3/4	38	6	31 1/2	1 1/8	1/2	H09ST	120
UV-125	132	134	12 3/4	36	6 5/8	29 3/8	1 1/8	1/2	H09ST	160
UV-150	156	158	12 3/4	42	6 5/8	34 1/2	1 1/8	1/2	H09ST	175
UV-200	206	208	14	46	7 1/2	37 1/2	1 3/8	1/2	H11ST	215
UV-275	283	286	16	48	8 1/8	39	1 5/8	1/2	valve-85A	250
UV-350	358	362	16	60	8 1/8	51	1 5/8	1/2	valve-85A	305
UV-450	463	468	18	62	8 3/4	52 1/2	1 5/8	1/2	valve-85A	440

* All pumpdowns are calculated at 80% of receiver volume

Use the following multipliers for refrigerants other than shown above:

R-12 = R-22 capacity × 1.10

R-502 = R-22 capacity × 1.01

R-404A = R-22 capacity × 0.89

R-507 = R-22 capacity × 0.88

Working Pressure: 450 psi

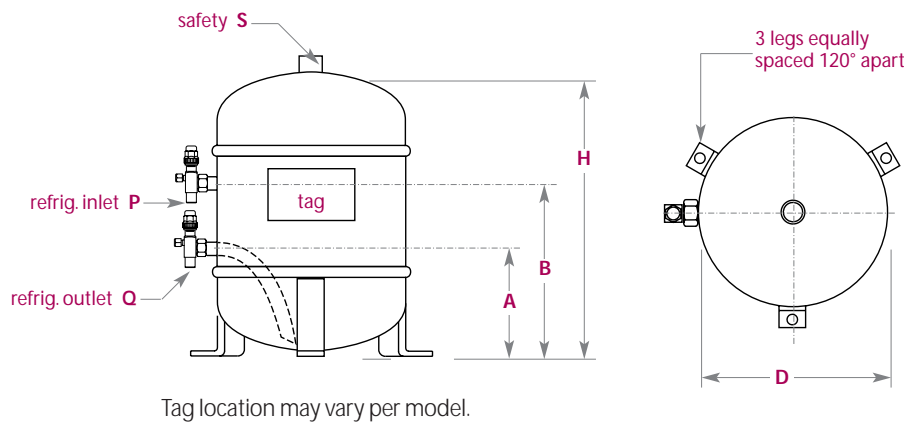



Compact Vertical Receivers

MODELS	Pumpdown* (lbs)		Dimensions (inches)				Connections			W Weld Screw	Ship Weight (lbs)
	R-22	R-502	B	D	H	A	P (flare)	Q	S (fpt)		
L-408C	2.9	2.95	na	4	8	2 11/16	3/8	3/8	1/8	3/8"-16 x 1	7
L-413C	5.0	5.10	3 1/2	4	13 1/2	2 1/2	3/8	3/8	3/8	3/8"-16 x 1	10
L-516C	9.3	9.45	3 1/2	5	16	2 1/2	1/2	1/2	3/8	3/8"-16 x 1	14
L-618C	15.3	15.56	3 1/2	6	18	2 1/2	1/2	1/2	3/8	1/2"-13 x 1	19
L-623C	19.7	20.03	3 1/2	6	23	2 1/2	1/2	1/2	3/8	1/2"-13 x 1	24
L-630C	25.3	25.7	3 5/8	6	30	2 1/2	5/8	5/8	3/8	1/2"-13 x 1	29

* All pumpdowns are calculated at 80% of receiver volume

Use the following multipliers for refrigerants other than shown above:

- R-12 = R-22 capacity x 1.10
- R-502 = R-22 capacity x 1.01
- R-404A = R-22 capacity x 0.89
- R-507 = R-22 capacity x 0.88

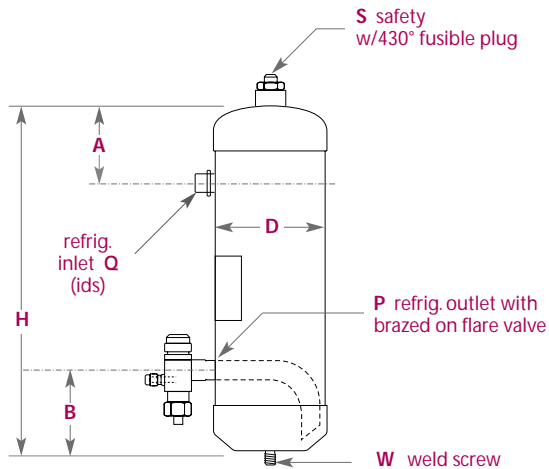

Working Pressure: 500 psi

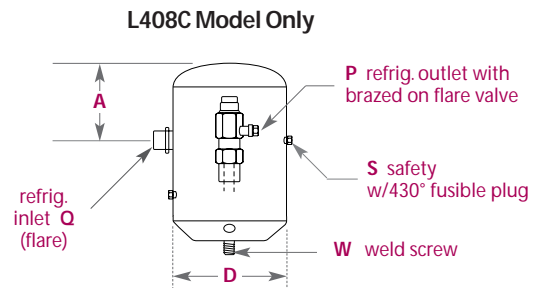

Suction Accumulators



design features & ratings

- Vertical installation for smaller footprint
- Prevents compressor damage due to slugging of refrigerant and oil
- Positive oil return at all rated conditions
- Designed for low temperature application
- Low pressure drop
- Acts as a suction muffler
- Corrosion resistant paint
- Fusible relief device available on larger models
- A.S.M.E. Coded Construction

MODELS	Refrig. Cap. (lbs)	Dimensions				Shipping Weight (lbs)	Recommended Tons of Refrigeration Suction Evaporator Temp. (°F)					
		R-22	A	B	C (ids)		E (ids)	R-22				
								+40°	+20°	0°	-20°	-40°
A-6118	21.8	6 5/8	23 1/2	1 1/8	NA	26	MAX	9.1	6.5	4.2	2.8	1.8
A-6118C			27 1/2		7/8	31	MIN	0.9	0.8	0.7	0.5	0.4
A-6138	21.0	6 5/8	23 1/2	1 3/8	NA	26	MAX	15.6	10.8	6.8	4.5	2.9
A-6138C			27 1/2		1 1/8	31	MIN	1.8	1.5	1.3	1.1	0.9
A-6158	20.1	6 5/8	23 1/2	1 5/8	NA	27	MAX	27.6	19.5	12.0	7.8	5.0
A-6158C			27 1/2		1 1/8	32						
A-8158	31.0	8 5/8	25 3/4	1 5/8	NA	42	MAX	3.2	2.4	2.0	1.6	1.5
A-8158C			29 1/2		1 3/8	47						
A-8218	30.0	8 5/8	22 3/4	2 1/8	NA	43	MAX	58.1	40.1	26.1	18.2	12.3
A-8218C			29 1/2		1 3/8	48						
A-10218	45.0	10 3/4	22 1/2	2 1/8	NA	65	MAX	6.1	5.6	4.6	4.1	3.2
A-10218C			25 1/2		1 5/8	70						
A-10258	44.0	10 3/4	22 1/2	2 5/8	NA	66	MAX	89.1	61.2	41.1	28.1	18.0
A-10258C			25 1/2		1 5/8	71						
A-10318	49.0	10 3/4	24 15/16	3 1/8	NA	72	MAX	132.2	92.1	61.3	40.4	28.0
A-10318C			25 1/2		1 5/8	77						
A-12318	73.0	12 3/4	25 1/2	3 1/8	NA	92	MAX	15.6	13.2	11.6	9.6	7.5
A-12318C			28 1/2		2 1/8	97						
A-14418	125.0	14	33 1/2	4 1/8	NA	157	MAX	250.0	175.0	116.0	76.0	54.0
A-14418C			36 3/4		2 1/8	162	MIN	33.0	28.0	25.0	20.0	16.0

Use the following multipliers for refrigerants other than shown above:
 Models with 'C' suffix include boil-out coil heat exchanger for additional protection.

R-404A= R-22 capacity × 0.89
 R-507= R-22 capacity × 0.88

Working Pressure: 450 psi

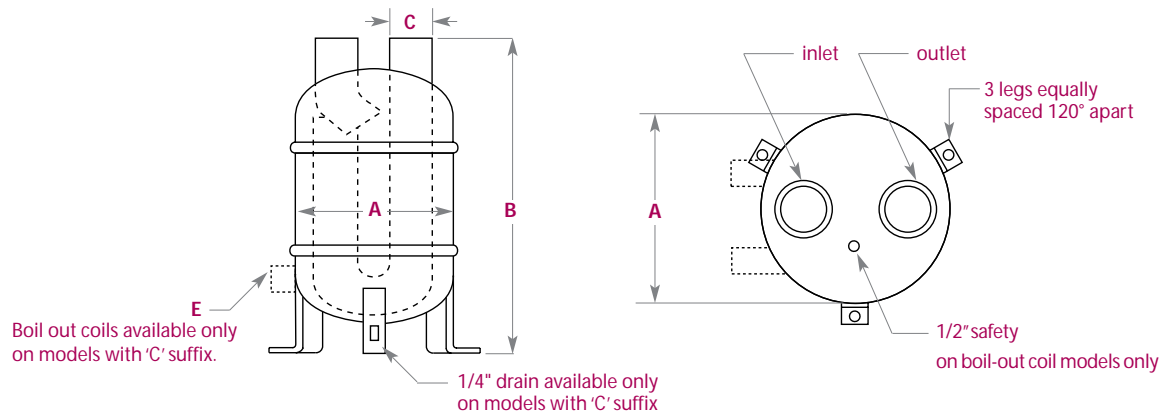

Suction Line Heat Exchangers



design features & ratings

- Patented spiral tube design with enhanced surface produces optimum turbulent flow and the highest heat transfer coefficients.
- The tightly-jacketed outer tube works in tandem with the enhanced surface spiral inner tube to produce minimum pressure drop and maximum heat transfer efficiency.

- Two-piece construction with rugged, high-temperature braze joints for fast, easy installation.
- Broad product range includes 10 SLC (copper) models from 1/2 hp to 20 hp, plus 5 SLS (carbon steel) models from 25 to 50 hp.
- Custom designs in copper or carbon steel are available to precisely fit your most exacting application requirements.
- All models are UL and CSA listed.

Copper Construction

All copper construction. Suitable for halocarbons. High temperature braze. Painted copper.

MODELS	Nom'l HP	A (IDS)	B (IDS)	C	D	E	F	G	Approx. WGT (lb)	DWP PSIG
SLC-1/2	1/2	1/4	1/2	11 1/2	10	9 7/8	7/8	3/4	1/2	450
SLC-1	1	3/8	5/8	14 1/4	11 7/8	11 7/8	7/8	1 1/4	3/4	450
SLC-1 1/2	1 1/2	3/8	7/8	14 1/4	11 7/8	11 7/8	1 1/8	1 1/4	1	450
SLC-2	2	3/8	1 1/8	14 1/4	11 7/8	11 7/8	1 3/8	1 1/4	1 3/4	450
SLC-3	3	1/2	1 1/8	14 1/4	11 7/8	11 3/8	1 3/8	1 1/4	1 3/4	450
SLC-5	5	5/8	1 3/8	14 1/4	11 3/8	11 7/8	1 5/8	1 3/8	2 1/4	400
SLC-7 1/2	7 1/2	5/8	1 5/8	16	12 7/8	13 3/8	2 1/8	1 5/8	3 1/2	400
SLC-10	10	7/8	2 1/8	17 1/4	11 7/8	13 1/4	2 5/8	2 1/4	6	400
SLC-15	15	7/8	2 1/8	21	16 3/4	18 1/8	2 5/8	2 1/8	8 1/2	400
SLC-20	20	1 1/8	2 1/8	21	16 3/4	19 1/4	2 5/8	2 1/8	8 1/2	400

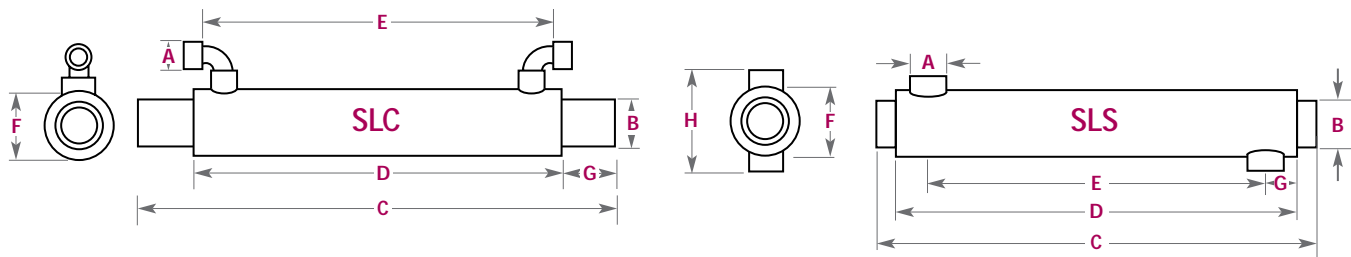

Steel Construction

All steel construction. Suitable for halocarbons. For ammonia applications please contact the factory. All joints heliarc welded. Painted black.

MODELS	Nom'l HP	A (IDS)	B (IDS)	C	D	E	F	G	H	Approx. WGT (lb)	DWP PSIG
SLS-25	25	1 1/8	2 5/8	38	32 1/2	29 3/4	3 1/2	1 3/8	5 3/4	21	400
SLS-30	30	1 3/8	2 5/8	38	32 1/2	29 3/4	3 1/2	1 3/8	6 1/4	21	400
SLS-35	35	1 3/8	2 5/8	40 1/8	34 1/2	31 7/8	3 1/2	1 3/8	6 1/4	23	400
SLS-40	40	1 3/8	3 1/8	31 3/4	26 1/4	22 3/4	4 1/4	1 3/4	7	29	350
SLS-50	50	1 5/8	3 1/8	31 1/4	26 1/4	22 3/4	4 1/4	1 3/4	7	29	350

For other sizes, materials and other special applications, please contact the factory.

Valves Rotalock®

design features & ratings

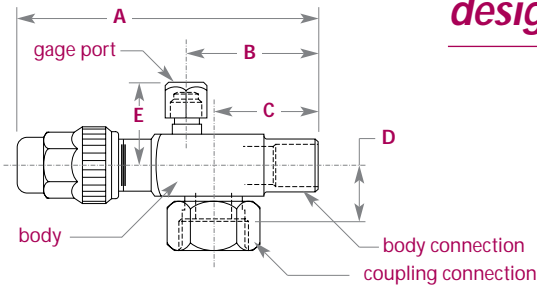

use stem end of valve & coupling connection as reference when determining gage port position

Connections		Top Gage Port	Left Gage Port	Right Gage Port	Body Size	Dimensions (inches)				
Body	Coupling					A	B	C	D	E
3/8 flare	3/4-16	H03FT	H03FL	H03FR	3/4 hex	3 23/32	1 17/32	1 3/16	25/32	1
1/2 flare	1-14	H04FT	H04FL	H04FR	7/8 sq	4 1/8	1 23/32	1 5/16	3/4	1 1/16
5/8 flare	1-14	H05FT	H05FL	H05FR	7/8 sq	4 3/8	1 31/32	1 9/16	3/4	1 1/16
1/2 ids	1-14	H04ST	H04SL	H04SR	7/8 sq	4 1/32	1 5/8	1 7/32	3/4	1 1/16
5/8 ids	1-14	H05ST	H05SL	H05SR	7/8 sq	4 9/32	1 7/8	1 15/32	3/4	1 1/16
7/8 ids	1 1/4-12	H07ST	H07SL	H07SR	1 1/8 sq	5 3/8	2 11/32	1 11/16	31/32	1 3/16
1 1/8 ids	1 1/4-12	H09ST	H09SL	H09SR	1 1/8 sq	5 5/8	2 19/32	1 15/32	31/32	1 3/16
1 3/8 ids	1 3/4-12	H11ST	H11SL	n/a	1 3/8 sq	7 3/16	3 5/16	2 15/32	1 3/16	1 5/16

use stem end of valve & body connection as reference when determining gage port position

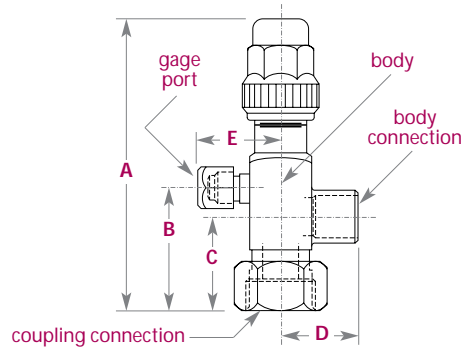

Connections		Top Gage Port	Left Gage Port	Right Gage Port	Body Size	Dimensions (inches)				
Body	Coupling					A	B	C	D	E
3/8 flare	3/4-16	V03FT	V03FL	V03FR	3/4 hex	3 1/16	1 5/32	13/16	1 1/8	1
1/2 flare	1-14	V04FT	V04FL	V04FR	7/8 sq	3 5/16	1 9/32	7/8	1 9/32	1 1/16
5/8 flare	1-14	V05FT	V05FL	V05FR	7/8 sq	3 5/16	1 9/32	7/8	1 17/32	1 1/16
1/2 ids	1-14	V04ST	V04SL	V04SR	7/8 sq	3 11/16	1 9/32	7/8	1 1/32	1 1/16
5/8 ids	1-14	V05ST	V05SL	V05SR	7/8 sq	3 11/16	1 9/32	7/8	1 1/32	1 1/16
7/8 ids	1 1/4-12	V07ST	V07SL	V07SR	1 1/8 sq	4 25/32	1 3/4	1 3/32	1 9/16	1 3/16
1 1/8 ids	1 1/4-12	V09ST	V09SL	V09SR	1 1/8 sq	4 25/32	1 3/4	1 3/32	1 13/16	1 3/16
1 3/8 ids	1 3/4-12	V11ST	V11SL	n/a	1 3/8 sq	6 3/16	2 5/16	1 15/32	2 3/16	1 5/16

Compressor Valves/ Indicator Components

part number valve-85A

used on RBV-72145 & RBV-96145
UV 275, UV350, UV 450

part number valve-621A

used on RBV-96166

Both valves utilize the four (4) bolt mating flanges installed on these receivers

horizontal refrigerant valves

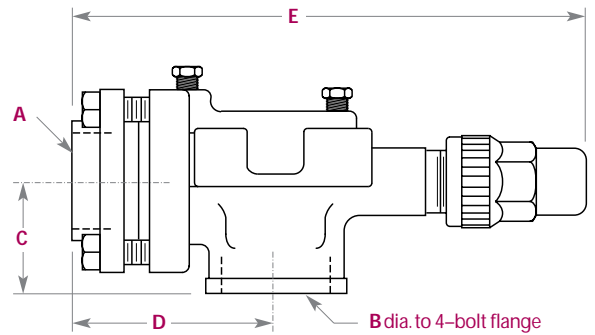

part number	Dimensions (inches)				
	A	B	C	D	E
valve-85A	1 5/8	2 1/8	1 13/16	3 15/16	9 1/2
valve-621A	2 1/8	2 17/32	2 3/8	5 1/16	12

part number GASKE 995

Neoprene flat gasket. Fits current indicator and alarm adaptor on units manufactured after 1972



part number INDIC 21

Replacement dial for LLI indicators



part number INDIC 49

Replacement switch for LLH alarms



LLI / LLH components

Indicators

liquid level indicator

LLI



Magnetic liquid level indicators are an inexpensive, effective means of gauging the refrigerant level in a horizontal receiver. The dial reads percent of pumpdown capacity of the receiver: when the pointer indicates 100%, the receiver is 80% full of liquid.

Pounds of refrigerant can be determined by taking the indicated percentage of the specified pumpdown capacity of the receiver.

Normal location is on the side of the receiver, centered between the liquid inlet and outlet connections. Other locations may be provided if specified. Note that at least six inches are required between centers of adjacent liquid level indicator flanges, and also between a unit and the liquid outlet pickup tube.

These can be mounted in the center of either end, provided the respective inlet or outlet fitting is moved to 1½ tank diameters from that end.

Float and assembly dial are included.

liquid level alarm

part number INDIC58A



A liquid-level indicator is a single pole, single throw switch on which contacts close upon the decrease of the liquid level at 20% pumpdown.

Movement of the seamless aluminum float rotates a magnet on the inner side of the solid aluminum alloy head. The indicator pointer, or switch contacts, are on the outer side and are operated by a small magnet which follows the position of the inner magnet. There is no connection, except the magnetic field, between the inside and outside. Internal gears and bearings are stainless steel.

In case of external damage, the indicator dial or switch cartridge may be replaced from outside—the refrigerant charge is not disturbed.

Switch Duty	AC
Max. Volts	120/240
Max. Amps	1 (inductive)
Max. Watts	75/150

liquid level indicator–alarm

part number INDIC210A

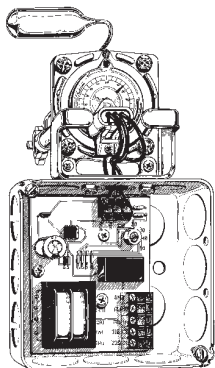

This indicator–alarm with selectable low–level point is designed for use in applications where low liquid level protection is desirable. It provides a relay circuit that closes at one of five user selectable levels of from 10 to 50%. The relay circuit can be used to drive a variety of applications from alarms to pumps. The indicator–alarm also provides a direct, visual indication of the liquid level in the tank.

Each indicator–alarm uses highly reliable and accurate, three wire, voltage divider technology to send the level signal to the level alarm, relay circuitry. The voltage divider uses thick film element in conjunction with a multi–fingered contact to ensure accuracy and reliability. The connector built into the indicator–alarm mates with a standard Packard automotive type, rubber sealed connector for easy installation and reliable connections.

Temperature	-20°C to 70°C (-4°F to 185°F), operating
Working Pressuer	410 PSIG
Power Rating	5 amps, 240 VAC max.
Voltage Input	110 or 220 VAC
Gauge Mounting	Rochester Senior™ Adapter
UL Status	UL recognized for refrigeration

All indicators require a factory installed flange and are available for 8" OD and larger horizontal receivers, only. Flange cost is not included in cost of indicator alarm.

Rotalock® Components

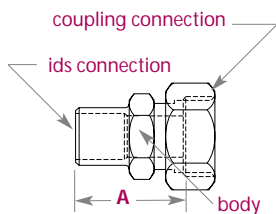

Connections		part number	Body	A (inches)
ids	coupling			
3/8	3/4-16	SA03	7/8 hex	1 9/32
1/2	1-14	SA04	7/8 hex	1 7/32
5/8	1-14	SA05	7/8 hex	1 9/32
7/8	1 1/4-12	SA07	1 1/8 hex	1 23/32
1 1/8	1 1/4-12	SA09	1 1/8 hex	1 31/32
1 3/8	1 3/4-12	SA11	1 3/4 hex	2 7/16

straight adapter

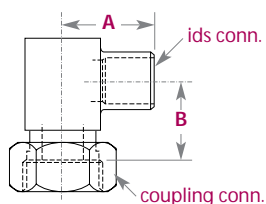

Connections		part number	A (inches)	B (inches)
ids	coupling			
3/8	3/4-16	AA03	1 5/16	1/2
1/2	1-14	AA04	1 3/32	17/32
5/8	1-14	AA05	1 3/32	19/32
7/8	1 1/4-12	AA07	1 9/16	5/8
1 1/8	1 1/4-12	AA09	1 13/16	1
1 3/8	1 3/4-12	AA11	2 3/16	1

angle adapter

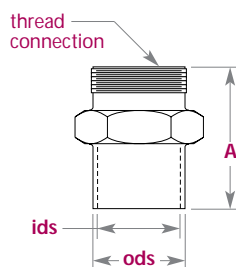

Connections			part number	A (inches)
ids	ods	thread		
3/8	1/2	3/4-16	BA03x06	1 5/16
3/8	1/2	1-14	BA03x08	1 5/16
1/2	5/8	1-14	BA04x08	1 5/16
5/8	7/8	1-14	BA05x08	1 5/16
5/8	7/8	1 1/4-12	BA05x10	1 9/16
7/8	1 1/8	1 1/4-12	BA07x10	1 9/16
1 1/8	1 3/8	1 1/4-12	BA09x10	1 9/16
1 1/8	1 3/8	1 3/4-12	BA09x14	1 11/16
1 3/8	1 5/8	1 3/4-12	BA11x14	1 11/16

brass adapter

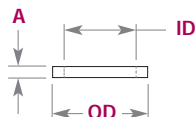

Dimensions (inches)			use with thread	part number
ID	OD	A		
7/16	9/16	1/16	3/4-16	TS-24590
5/8	3/4	1/16	1-14	TS-24591
7/8	1	1/16	1 1/4-12	TS-24592
1 3/8	1 1/2	1/16	1 3/4-12	TS-24593

teflon fiber seal



valve and component notes

Steel valves and adapters with ids connections are electroplated and can be silver soldered. The valve stem packing can withstand considerable heat, but should be kept as cool as possible. Valves should be slightly open while soldering.

Teflon seals should be installed only after all soldering is completed. A seal is furnished with each valve, adapter or connection supplied on a vessel. Order additional seals for replacement only.

Steel valves with flare connections are cadmium plated. The stem packing will not withstand soldering temperatures, and the valve body must be protected if soldering is done near the valve.

Protection / Indicators

fusible unions



part number	Connections		temperature setting
	flare	mpt	
union-184	3/8	3/8	212° F
union-58	3/8	1/2	212° F
union-319	3/8	5/8-18UNF	212° F
union-67	3/8	1/2	275° F
union-76	3/8	3/8	283° F

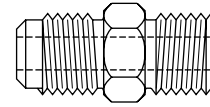

fusible plugs



part number	thread size (mpt)	temperature setting
plug-148	1/8	212° F
plug-175	3/8	212° F
plug-265	5/8-18UNF	212° F
plug-166	1/8	283° F
plug-337	3/8	283° F
plug-364	5/8-18UNF	283° F

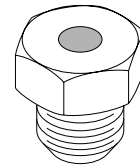

relief valves



part number	Connections		pressure setting
	mpt	flare	
valve-58	3/8	3/8	350 psi
valve-67	3/8	3/8	400 psi
valve-94	1/2	5/8	350 psi
valve-102	1/2	5/8	400 psi
valve-764	1/2	5/8	450 psi
valve-771	3/8	3/8	450 psi

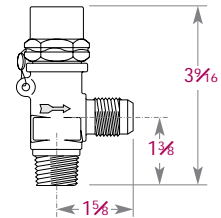

protection notes

Relief valves are installed in a refrigeration system primarily to protect the vessel in the event of fire or other emergency high pressure condition.

Fusible unions and plugs protect only in the event of fire.

The 5/8-18UNF union or plug seats in a special 3/8" coupling with a copper zinc coated flare gasket, exactly as an SAE flare fitting. A conventional 3/8" mpt pipe threaded union, plug, or safety valve will also seal on the dryseal pipe thread of the coupling if ever necessary.

All systems must have a relief valve or fuse plug installed in order to comply with the ANSI B9.1 code.

sight glasses



part number	thread size	bulls-eye type
SG04	1/2 mpt	float ball
SG06	3/4 mpt	float ball
SG08	1 mpt	float ball
SG10	1 1/4 mpt	float ball
SG11	2 mpt	float ball
SG12	1 1/4 -12 3/4 ROTALOCK	float ball

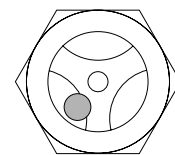

Brackets

universal

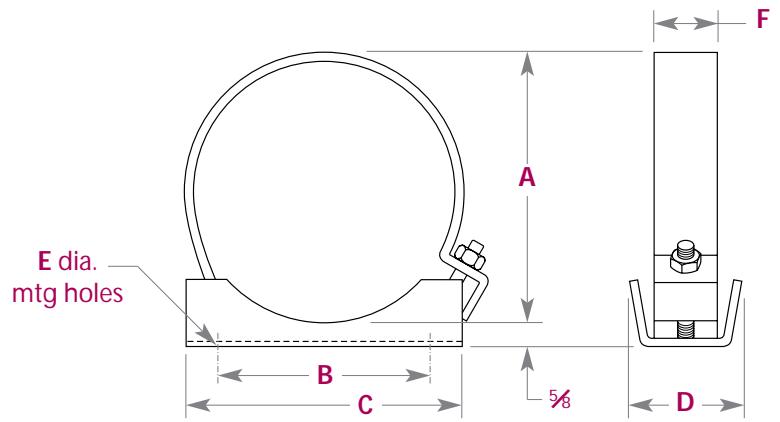

part number	Dimensions (inches)					
	A	B	C	D	E	F
5A	5	5 1/2	7	2 9/16	7/16	1 1/16
6A	6	5 1/2	7	2 9/16	7/16	1 1/16
6B	6 5/8	5 1/2	7	2 9/16	7/16	1 1/16
8B	8 5/8	8	9	2 7/8	7/16	1 1/16
10B	10 3/4	10	11	3 5/16	7/16	1 1/16
12B	12 3/4	11 5/8	13	4 1/8	9/16	1 1/2
14B	14	13 1/4	14 1/2	4 1/8	9/16	1 1/2
16B	16	15 3/4	17	4 1/8	9/16	1 1/2

compressor / condenser

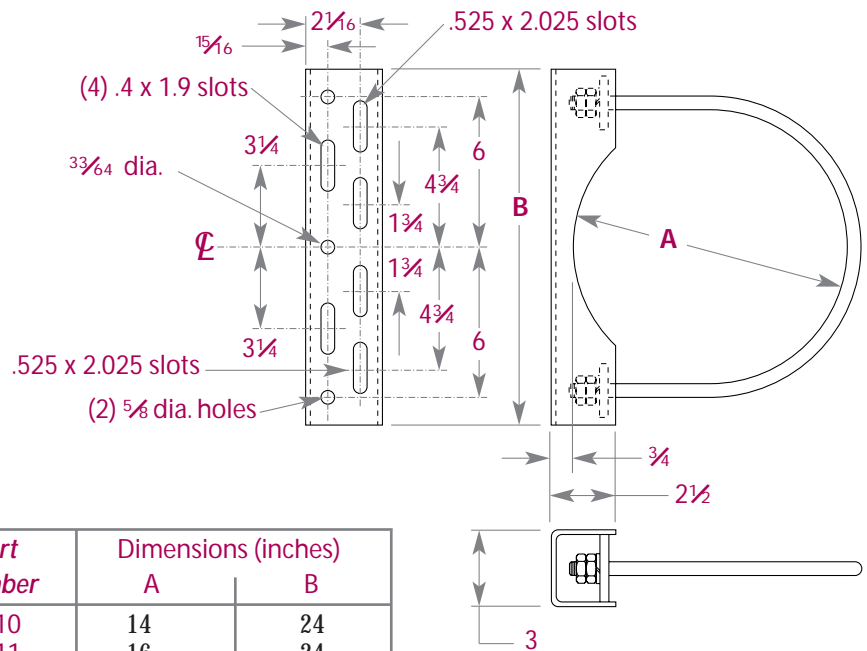

part number	Dimensions (inches)		part number	Dimensions (inches)	
	A	B		A	B
BR1	6	14	BR10	14	24
BR3	6 5/8	14	BR11	16	24
BR5	8 5/8	14	BR12	18	24
BR7	10 3/4	14	BR13	20	24
BR9	12 3/4	14			

Industrial Refrigeration Products



OCS



OCSF



TSC



OTW



AMC



AOP



AFV

Standard Refrigeration designs and manufactures a wide variety of industrial refrigeration products. Most cataloged products have been designed for use with R-717 ammonia. Products for industrial applications with halocarbons are also available.

Custom Designed Product

Due to the highly application-specific nature of most industrial refrigeration systems, many of Standard Refrigeration's heat exchangers and vessels are custom designed to meet our customer's needs. Components can be designed specifically to meet refrigerant, media and temperature requirements and a wide variety of materials can be specified as well. Vessels can be constructed to diameter sizes up to 60 inches.

Reciprocating Compressor Coalescing Oil Separators

Available in both hermetic and serviceable designs, coalescing oil separators provide oil separation and limit oil carry-over to approximately 3–10 pounds of oil per million pounds refrigerant depending on system characteristics such as operating conditions, refrigerant, start/stop and load/unload frequency, etc. Typical oldstyle mesh pad separators have carry-over rates on the order of over 10 times that amount. The coalescing oil separator provides a product that will assist in alleviating these concerns.

The OCS and OCSF line of coalescing separators is designed for reciprocating refrigeration compressors and suitable for ammonia (R-717), halocarbons (R-22, R-134a) and hydrocarbons such as propane (R-290).

Screw Compressor Coalescing Oil Separators

Screw compressors require increased oil flow and often require larger separator volume and additional separation methods. Oil separators can be custom designed to your screw compressor application.

Oil Coolers

Standard catalogs both ammonia thermosiphon and water-cooled oil cooler designs. Ammonia thermosiphon models are rated for use with 4GS oil at 130°F out and 95°F R-717 saturation, R-717 @ 4:1 overfeed and 0.0005 fouling factor. Water-cooled oil coolers are rated for use with 4GS oil at 180°F inlet and 135°F outlet, 85°F water inlet and 95°F water outlet. Custom units are available upon request.

Ammonia Flooded Evaporators

Flooded evaporators are available and can be custom designed to meet your application needs. Units can be custom designed with surge tanks, flange and special connections, waterboxes, sightglasses, oil skimmers, oil pots and level indicator connections. Flooded evaporators are generally built with carbon steel shell and tubing. Stainless steel or titanium tubing options are available as well.

Ammonia Water-Cooled Condensers

AMC water-cooled condensers are constructed with carbon steel shells and tubing and are cataloged for use with ammonia from 5 HP to 1,500 HP.

Ammonia Oil Pots

AOP oil pots are constructed with carbon steel shells and are built to 400 psi working pressure.

OCS OCSF

Coalescing Oil Separators



specification information

MODELS	Gas Inlet	Gas Outlet	S NPTF	Dia	L	A	B	C
OCS-035	2	2	1/2	10 3/4	29	6 3/8	4 1/2	3 1/2
OCS-070	2 1/2	2 1/2	1/2	12 3/4	35	6 1/8	4 1/2	4
OCS-145	3	3	1/2	16	42	8 5/8	4 1/2	5 1/4
OCS-215	4	3	1/2	18	55 3/4	11 1/8	6	5 1/4
OCS-250	5	3	1/2	20	56 1/4	9 5/8	6	6
OCSF 037*	2 1/2	2 1/2	1/2	12 3/4	35	29 1/2	5 3/8	4
OCSF 147*	3	3	1/2	16	42 3/8	36 7/8	6	5 1/4
OCSF 217*	4	4	1/2	18	55 5/8	48 5/8	7 7/8	5 1/4
OCSF 252*	5	5	1/2	20	57 5/8	50 5/8	9	6

- OCS models feature welded sealed construction to eliminate gaskets
- OCSF models feature removeable flanged head design for easy changing of coalescer element
- Models to 250 DCFM Ammonia
- For use with Ammonia or Halocarbon refrigerants
- Horizontal or space saving vertical installation

* OCSF models have removeable flanged heads and replacement filters.

Note: use F suffix for optional flange gas fittings (eg. OCS-145F).

MODELS	Replacement Gasket	Replacement Flange	Replacement Coalescer	Coalescer OD	Coalescer ID	Coalescer Length
OCSF 037	3037	1974	SEPAR 21	6	3	12
OCSF 072	3044	2441	SEPAR 38	7	4	18
OCSF 147	3051	2472	SEPAR 45	9.4	6.13	24
OCSF 217	3068	2465	SEPAR 52	9.4	6.13	34
OCSF 252	3075	2489	SEPAR 69	10.63	7.63	34

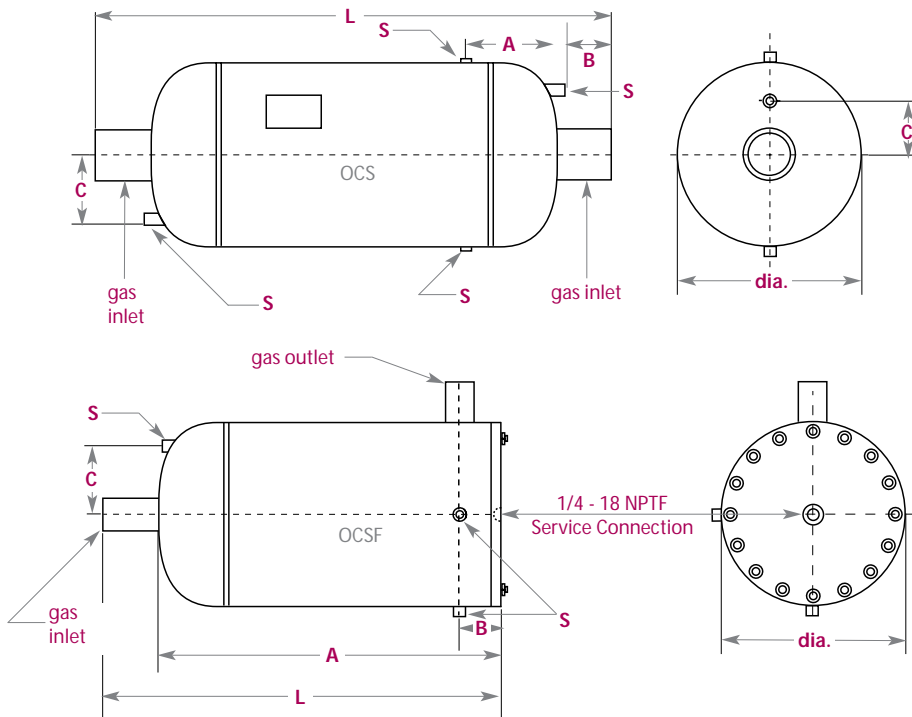

NOTE: Horizontal or Vertical Installation will determine the functions of the 1/2" NPTF connections. Fittings can serve as oil out, float vent, or safety. Refer to the OCS/OCSF installation manual for correct usage.

NOTE: OCS & OCSF models are designed for reciprocating compressor use. Contact factory for screw compressor applications.

TSC

Ammonia Thermosyphon Oil Coolers

specification information



Materials:

Tubes — .035 wall carbon steel
 Shell — carbon steel SA53B ERW
 Fittings — carbon steel

Construction:

Code — ASME
 Tubes — rolled

Working Pressures:

400 psi shell side +20°F to 200°F
 350 psi tube side +20°F to 200°F

Performance Ratings:

The oil coolers listed are rated under the following conditions. 4GS oil, 130°F out, 95°F ammonia saturation. Refrigerant R-717 @ 4:1 overfeed, fouling factor 0.0005. Complete performance data is available from the factory.

Custom Designs:

Custom designs with special materials are available from the factory.

MODELS	Dimensions			Connections				Shipping Weight (lbs)
	Dia	Length	Depth	refrig		oil		
				inlet	outlet	inlet	outlet	
TSC-0505	5 5/16	84	15	2	2 1/2	2	2	190
TSC-0507	5 5/16	108	15	2	2 1/2	2	2	250
TSC-0509	5 5/16	132	15	2	3	2	2	310
TSC-0607	6 5/8	108	16 5/16	2 1/2	3	2	2	400
TSC-0609	6 5/8	132	16 5/16	3	4	2	2	560
TSC-0807	8 5/8	108	18 1/16	3	4	3	3	540
TSC-0809	8 5/8	132	18 1/16	4	5	3	3	660
TSC-1007	10 3/4	108	20 3/8	4	5	3	3	790
TSC-1009	10 3/4	132	20 3/8	5	6	3	3	1010

All connections are pipe connections unless otherwise noted.

Standard Industrial Refrigeration Products reserves the right to change dimensions without notice.

Contact the factory for a final drawing before ordering.

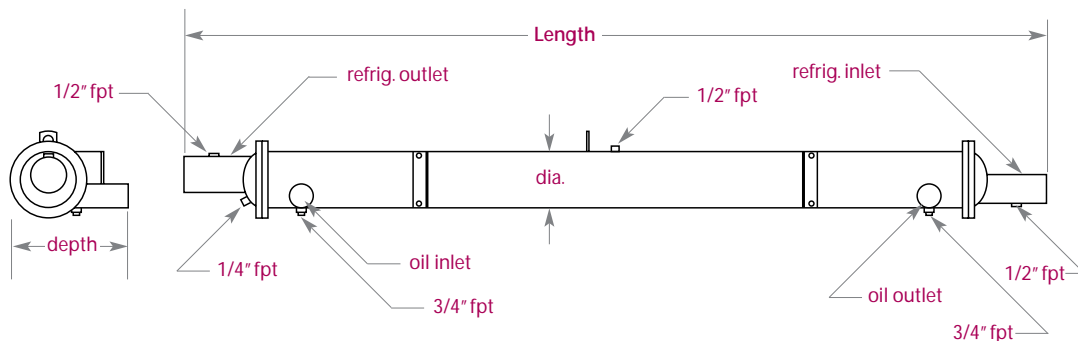

OTW

Water Cooled Oil Coolers

specification information

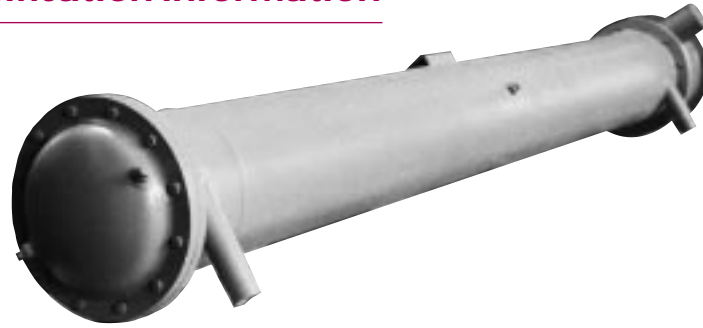

Materials:

Tubes — .065 wall carbon steel ERW
 Shell — carbon steel SA53B ERW
 Fittings — carbon steel

Construction:

Code — ASME or UL
 Tubes — sealed welded

Working Pressures:

400 psi shell side +20°F to 200°F
 225 psi tube side +20°F to 200°F

Performance Ratings:

The water cooled oil coolers listed are rated at the following conditions.
 180°F 4GS oil in, 135°F 4GS oil out, 85°F water in, 95° water out.

MODELS	Dimensions				Connections		Shipping Weight (lbs)
	Dia	Length	W	F	Water fpt	Oil fpt	
OTW0810	8 ⁵ / ₈	128 ¹ / ₈	12 ³ / ₈	11 ⁵ / ₈	2	2	1100
OTW1009	10 ³ / ₄	120 ¹ / ₂	16 ³ / ₈	14	3*	2 ¹ / ₂	1300
OTW1209	12 ³ / ₄	119 ⁹ / ₁₆	18 ¹¹ / ₁₆	16 ⁵ / ₈	3	2	1700
OTW1409	14	119 ¹³ / ₁₆	19 ¹³ / ₁₆	17 ⁵ / ₈	4	2	1850
OTW1608	16	108 ¹⁵ / ₁₆	22	19 ¹⁵ / ₁₆	4	2	2350
OTW1609	16	127 ¹ / ₄	22	19 ¹⁵ / ₁₆	5**	3	2350

* water box *flange

All connections are pipe connections unless otherwise noted.

Standard Industrial Refrigeration Products reserves the right to change dimensions without notice.

Contact the factory for a final drawing before ordering.

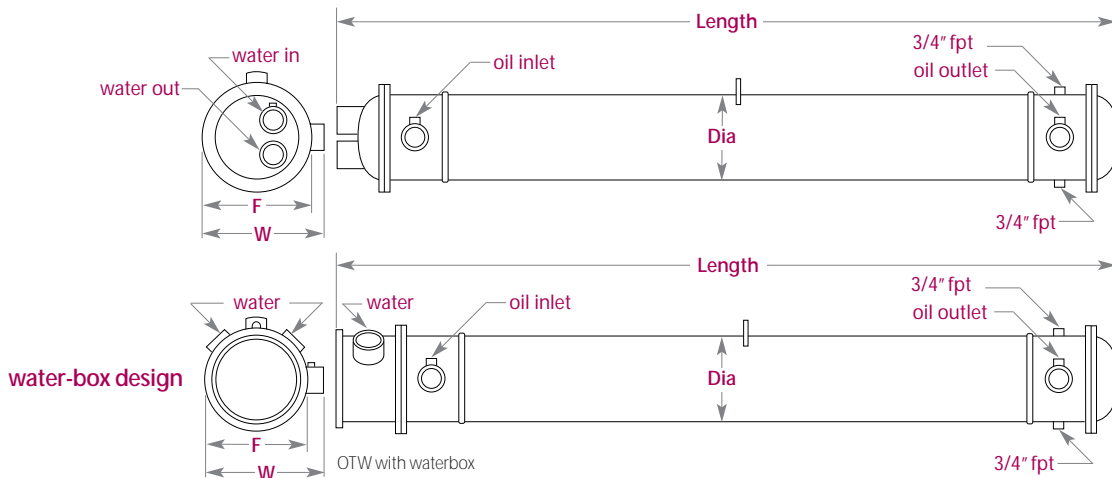

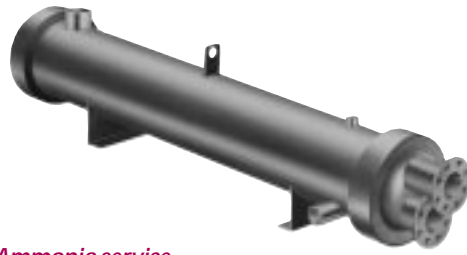

design features & ratings

- Ammonia service
- Carbon steel tubes, tubesheets, shell, water plates and fittings
- Horizontal, shell and tube design
- Manufactured per ASME pressure vessel code, section VIII
- 11 AMC models

MODELS	Dimensions			Connections		Water (flange)	Shipping Weight (lbs)
	Dia.	Length	Height	Refrig. (nom'l) Inlet	Outlet		
AMC-0610-2	6 ⁵ / ₈	128	11	1	³ / ₄	1 •	500
AMC-0810-2	8 ⁵ / ₈	128 ¹ / ₄	12 ⁷ / ₈	1 ¹ / ₂	1	2 ¹ / ₂ •	650
AMC-1010-2	10 ³ / ₄	132 ¹ / ₂	14 ⁵ / ₈	2	1 ¹ / ₄	4 •	1000
AMC-1210-2	12 ³ / ₄	134 ¹ / ₂	16 ¹ / ₂	2 ¹ / ₂	1 ¹ / ₂	4 •	1550
AMC-1410-2	14	135 ⁵ / ₈	17 ⁷ / ₈	3	2	4	1770
AMC-1610-2	16	137 ⁷ / ₈	19 ⁷ / ₈	3 ¹ / ₂	2	5	2100
AMC-1810-2	18	137 ⁵ / ₈	21 ⁷ / ₈	3 ¹ / ₂	2 ¹ / ₂	6	2800
AMC-2010-2	20	141 ³ / ₄	23 ⁷ / ₈	4	2 ¹ / ₂	6	4000
AMC-2410-2	24	144	27 ⁷ / ₈	5	3	8	4600
AMC-3010-2	30	150	36	6	4	12 †	5900
AMC-3610-2	36	156	42	10	5	16 †	8100

•fpt † water box

Horizontal or vertical water box fittings are available. Please specify.
Standard Refrigeration reserves the right to change dimensions without notice.
Contact the factory for a final drawing before ordering.

Working Pressures:

350 psi. shell side + 20° F to 200° F

225 psi. tube side + 20° F to 200° F

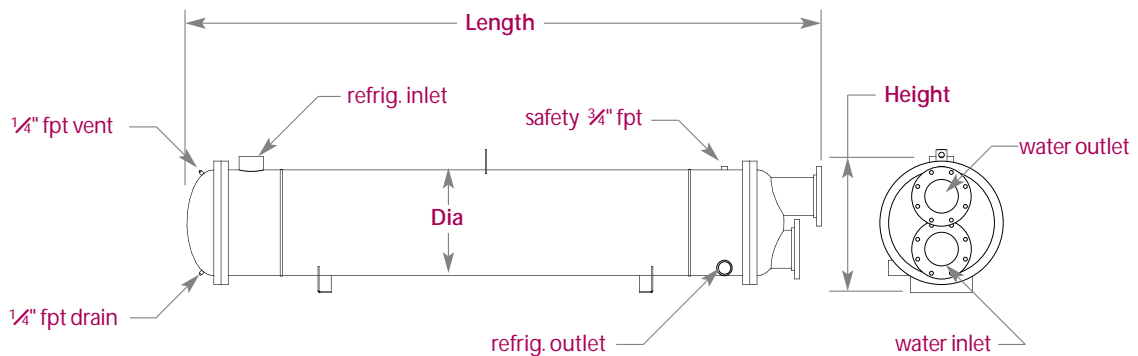

AOP

Ammonia Oil Pots



design features & ratings

Materials:

Shell — carbon steel SA53BERW

Construction:

Code — ASME

Working Pressures:

400 psi

Custom designs available.

MODELS

	D	L	A	B	C	H	I	In fpt	Out mpt	Vent fpt	Shipping Weight
AOP-638	6 5/8	40	4 5/8	19	33 3/8	7 3/16	5 3/4	1 1/4	3/4	1	42
AOP-838	8 5/8	40	4 5/8	19	33 3/8	8 3/16	5 1/8	1 1/4	3/4	1	68
AOP-1038	10 3/4	40	5 5/8	19	32 3/8	9 1/4	9 1/4	1 1/4	3/4	1	118

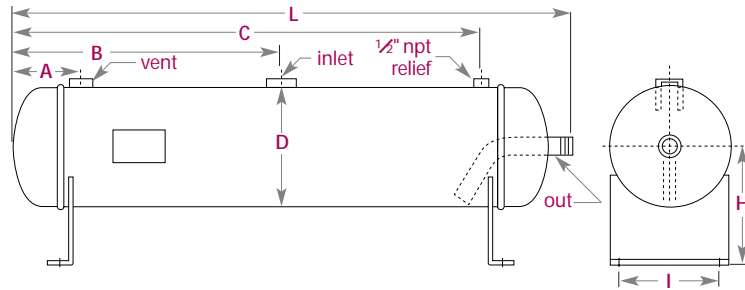

AFV

Ammonia Flooded Evaporators



Custom designed ammonia evaporators are available. Please contact local sales representative or the factory for more information

Condenser Specification Data

Photo Copy and Fax to:
Standard Sales Department
708 345 3513
or via the World Wide Web
www.stanref.com/quote.htm

Customer Information

Company _____

Contact Name _____ Date _____

Phone _____ Fax _____

Performance

inlet fluid temperature _____ °F

condensing refrigerant temperature _____ °F

fouling factor (.00025 ARI standard) _____

THR _____ Btu/hr

refrigerant _____

pressure drop _____ psi

Fluid Circulated

water _____ %

propylene glycol _____ %

sodium chloride (NaCl) _____ %

ethylene glycol _____ %

calcium chloride (CaCl₂) _____ %

other _____ %

If other, specify properties at inlet temperature

specific gravity _____

thermal conductivity _____

viscosity (centipose) _____

specific heat _____

Construction

size: width _____ length _____ height _____

materials: shell _____ tube _____

connections: refrigerant inlet _____ refrigerant outlet _____

specify ids, fpt,
flange or flare

fluid inlet _____ fluid outlet _____

Application

Custom Design Chiller Specification Data

Photo Copy and Fax to:
Standard Sales Department
708 345 3513
or via the World Wide Web
www.stanref.com/quote.htm

Customer Information

Company _____

Contact Name _____ Date _____

Phone _____ Fax _____

Chiller Design

- DX serviceable, no. circuits _____
- Flooded serviceable

Performance

inlet fluid temperature _____ °F
outlet fluid temperature _____ °F
net load _____ tons
pressure drop _____ psi
fouling factor _____ (0.0001 ARI standard)
Refrigerant 22, 134A, 404A, NH3, other _____
suction temperature _____ °F of refrigerant at evaporator

Fluid Circulated

- water _____ %
- ethylene glycol _____ %
- propylene glycol _____ %
- calcium chloride (CaCl₂) _____ %
- sodium chloride (NaCl) _____ %
- other _____ % if other,
specify properties at outlet temperature:
specific gravity _____
viscosity (centipoise) _____
thermal conductivity _____
specific heat _____

Construction

size: width _____ length _____ height _____
materials: shell _____ tube _____
working pressures: shell _____ psi tube _____ psi
connection sizes: refrigerant inlet _____ refrigerant outlet _____ fluid inlet _____ fluid outlet _____

Application



warranty

Liability and Limitations

All products are thoroughly inspected and tested before leaving the factory, and are guaranteed against defects in material and workmanship to the extent expressly provided in this Paragraph. If it is proven to Standard/Stanref satisfaction that any part of any such product was defective when shipped from the factory, and such part is returned to Standard's factory in Melrose Park, Illinois or Stanref's factory in Bury St. Edmunds within twelve months of date of shipment thereof, transportation prepaid, Standard/Stanref shall either furnish a replacement part or repair such part (whichever Standard/Stanref may elect) free of charge and shall return such replacement part or repaired part to Purchaser, transportation prepaid. The foregoing shall not apply and Standard/Stanref shall have no obligation under this Paragraph with respect to any part or product which Standard/Stanref determines was subject to abuse, misuse, or improper installation or application. EXCEPT AS EXPRESSLY PROVIDED ABOVE, STANDARD/STANREF MAKES NO GUARANTEE OR WARRANTY EXPRESS OR IMPLIED WITH RESPECT TO ANY PRODUCTS SOLD HEREUNDER OR ANY PART OF ANY SUCH PRODUCT, INCLUDING (WITHOUT LIMITING THE GENERALITY OF THE FOREGOING) WARRANTIES OF MERCHANTABILITY AND WARRANTIES OF FITNESS OR SUITABILITY FOR ANY PARTICULAR PURPOSE, and Standard/Stanref shall have no other liability whatsoever with respect to such products or parts including (without limitation) any liability for indirect, consequential or resultant damages whether based upon breach of warranty, negligence or any other ground, it being understood that replacement or repair of defective parts as herein provided shall be Purchaser's sole and exclusive remedy.

Changes and Improvements

Changes and improvements may be made at any time in Standard and Stanref products, but Standard Refrigeration Company and/or Stanref International PLC shall be under no obligation to incorporate same in, or substitute the same for any products previously sold to any customer.

Merchandise Returned for Credit

No merchandise will be accepted for credit unless authority of the factory has been first obtained. Only merchandise of current design, in their original individual cartons will be considered for return—and if returned, a handling charge of 12% of the original net purchase price, plus transportation, will be made. No provision is made for the return of merchandise of special nature, and orders for special merchandise are not subject to cancellation.

Engineering Assistance

For assistance in the design, specification or use of Standard products, please contact your nearest sales representative or our office headquarters in Melrose Park, Illinois. In the United Kingdom contact Stanref International in Bury St. Edmunds, England.

Engineering specifications in this catalog are current as of the printing date, but are subject to future design changes. Consult factory for latest specification data before ordering.

Product performance is based on ARI standards and nominal operating conditions Standard Refrigeration Company is not responsible for product failure in nonconforming applications. For assistance, please consult the factory.